

www.kidsactivitydownloads.com

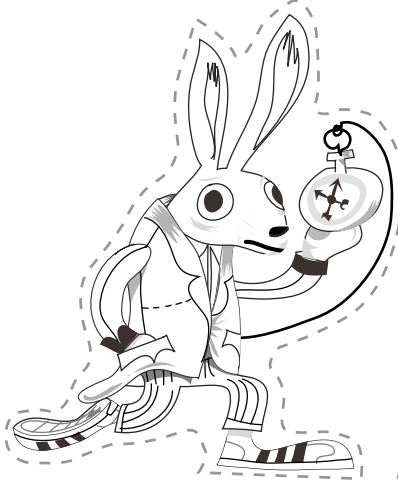

Kids Activity Downloads

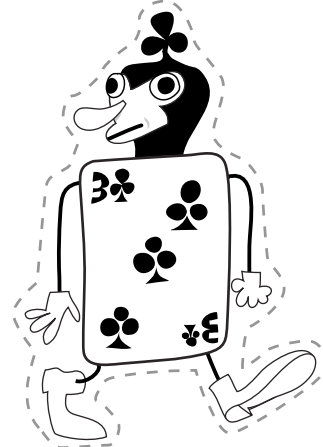
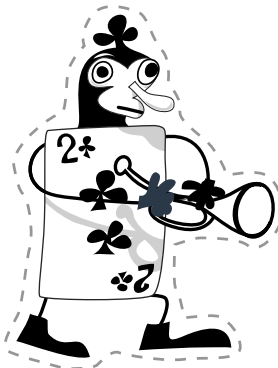
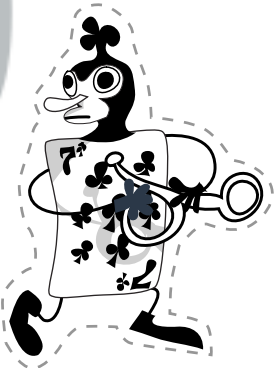
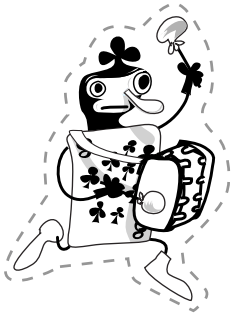

Cut out these characters and paste or tape them to a strip of folded paper. Then attach that strip to the coloring page to create your own pop-up wonderland.

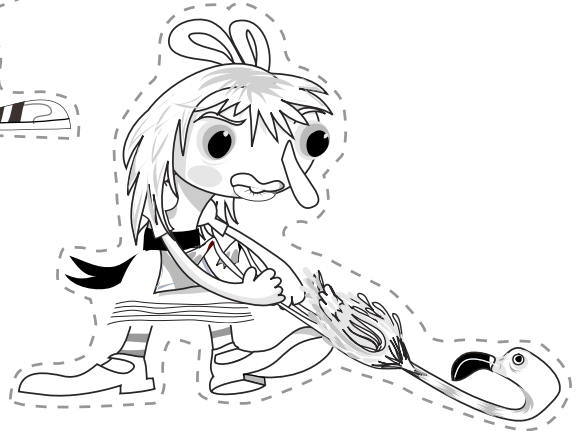

Fold me along the lines. Then paste or tape one end to a character and the other to the coloring page.

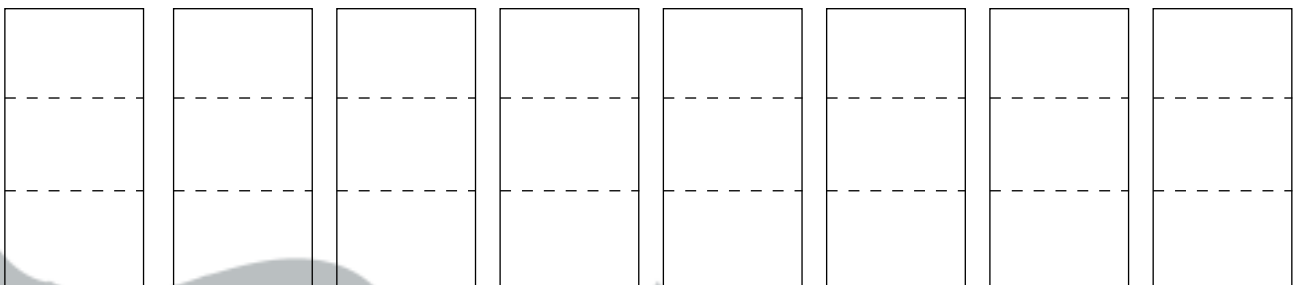

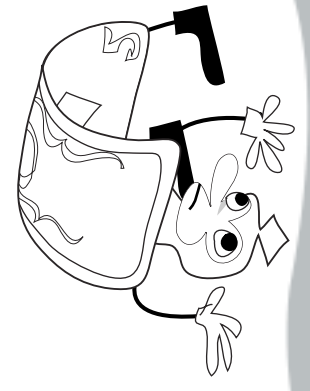
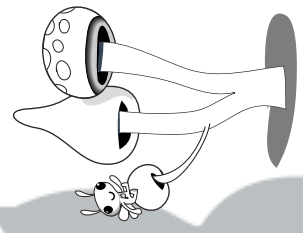
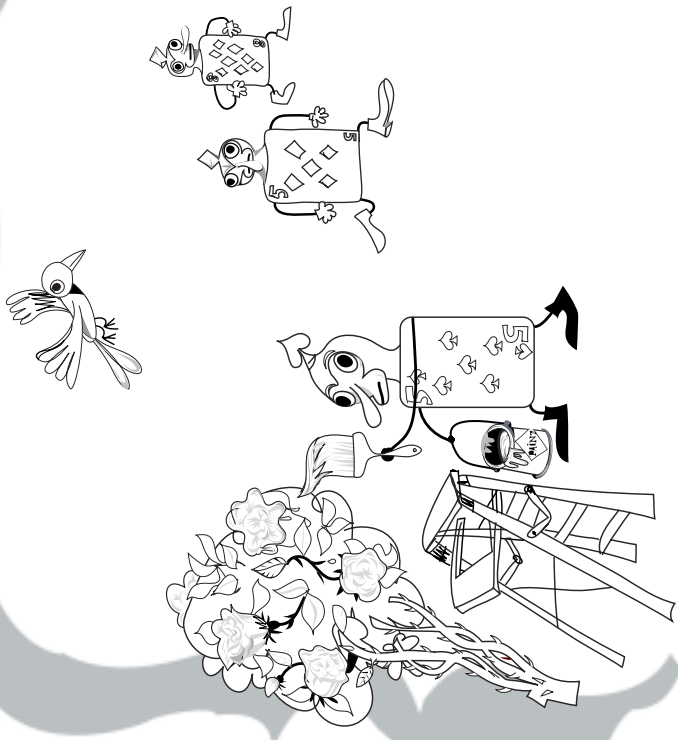

Detective LITTLE BOY BLUE



by STEVE METZGER illustrated by TEDD ARNOLD

 SCHOLASTIC

WWW.SCHOLASTIC.COM



MY NAME IS BLUE -
DETECTIVE BLUE.
YOU MIGHT KNOW ME
AS LITTLE BOY BLUE.

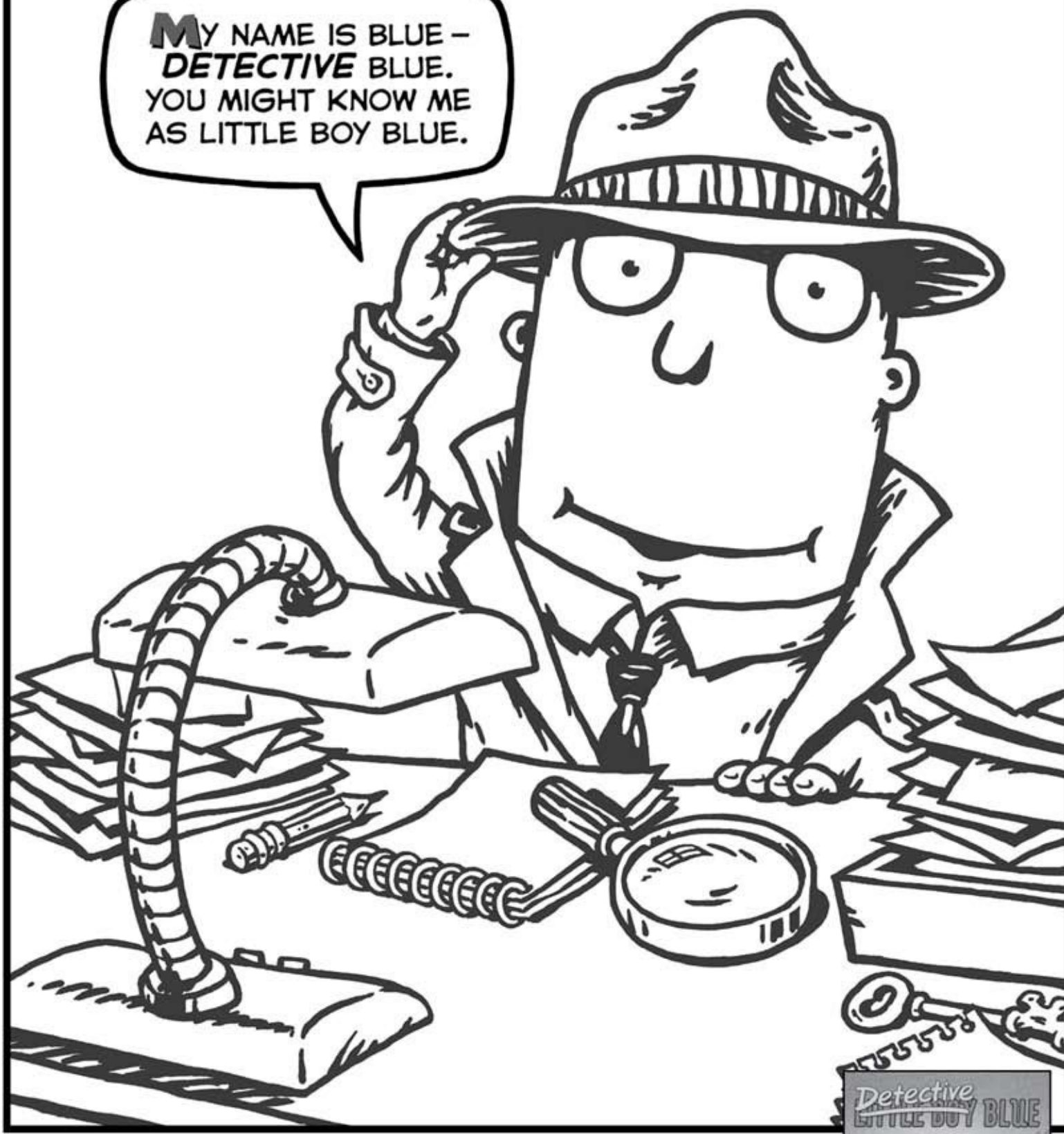

by STEVE METZGER illustrated by TEDD ARNOLD



 SCHOLASTIC

WWW.SCHOLASTIC.COM

MARY'S LAMB **ALMOST** MADE
IT INTO THE SCHOOLHOUSE.

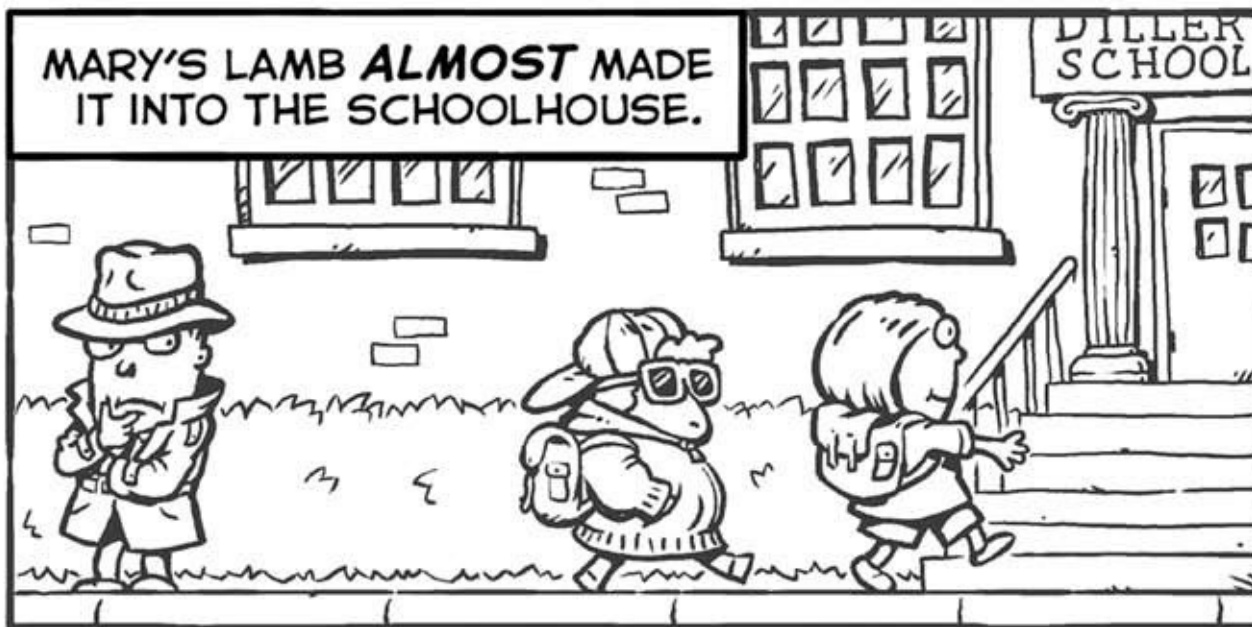

I SEE THROUGH
YOUR **DISGUISE!**

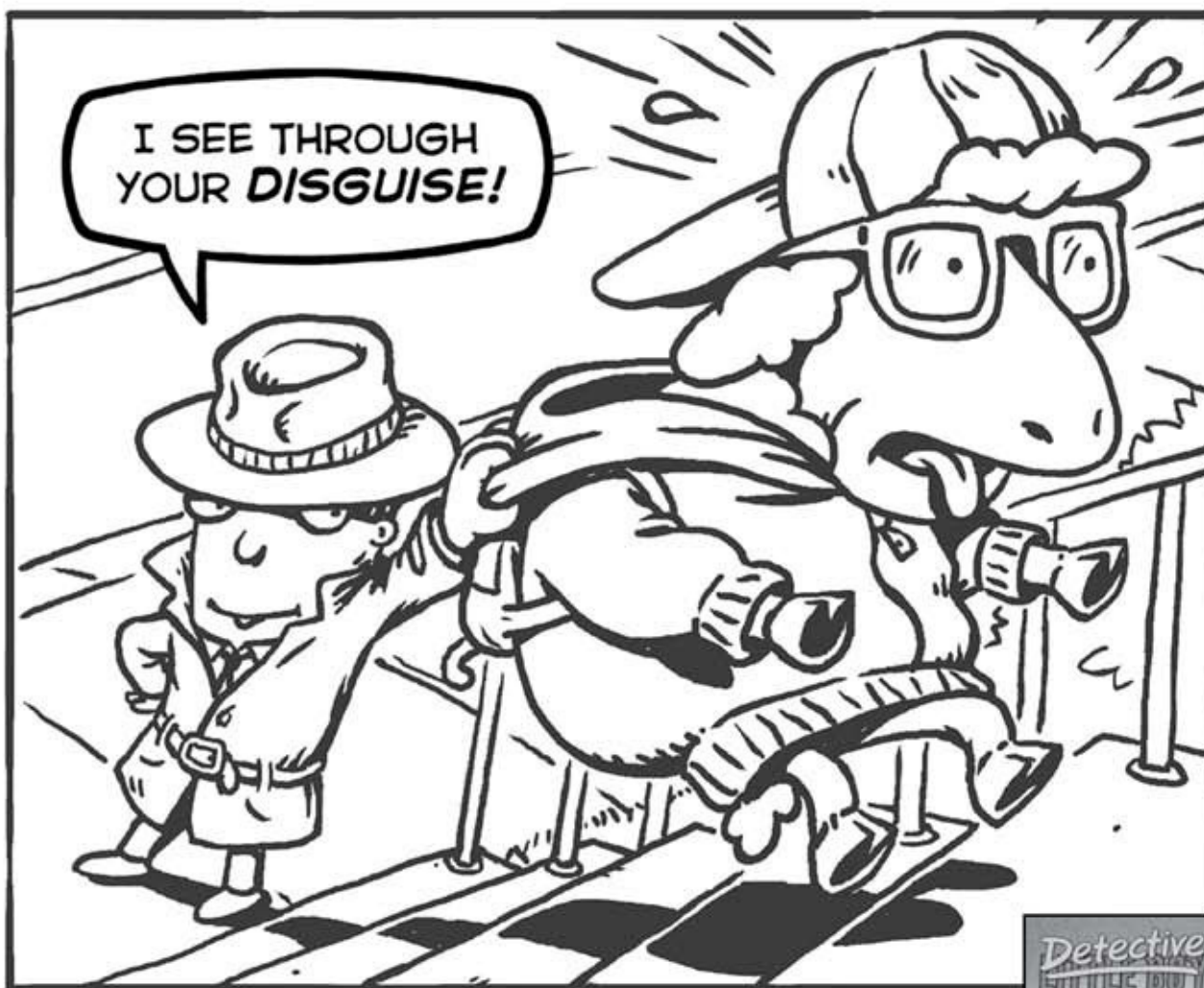

by STEVE METZGER illustrated by TEDD ARNOLD

 SCHOLASTIC

WWW.SCHOLASTIC.COM

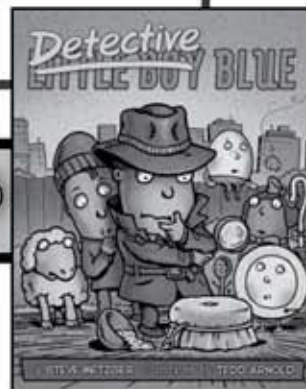

Host a DINO-mite Story Hour Event!

Inside this kit you will find:

- **5 Reproducibles:**

- 1 Announcement/Invitation (Reproducible A)

- 4 Coloring and Activity Sheets (Reproducible B–E)

- **30 DINO-mite Stickers**

- **1 Reading Is DINO-mite! Poster**



And don't forget to prepare ahead of time!
Make sure you have these delightful books by
Jane Yolen and Mark Teague

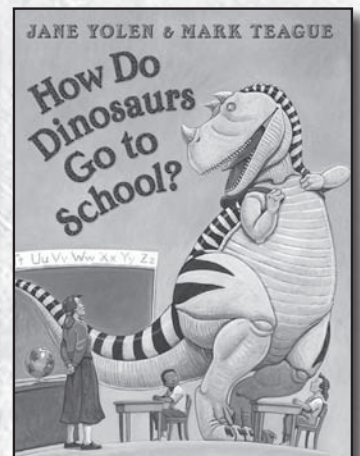
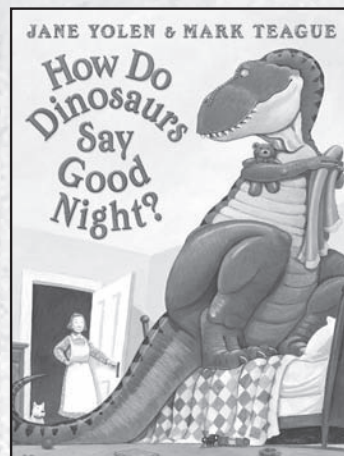
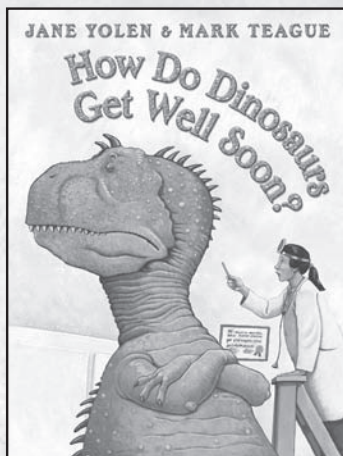
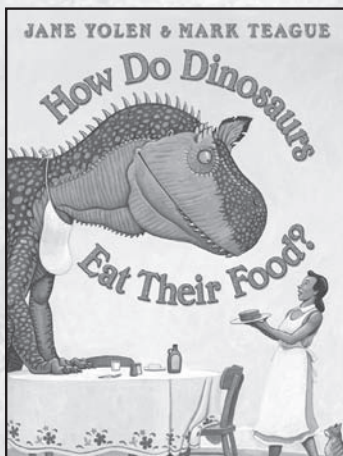

Join Us for a DINO-mite Story Hour Event!



Date: _____

Time: _____

Place: _____

R.S.V.P. By: _____

Phone: _____

E-mail: _____



How do YOU go to school?

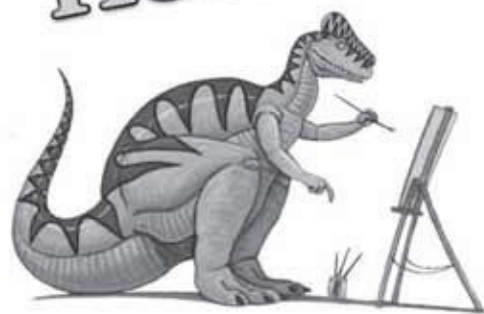

Do you walk?

Do you ride in a bus or car pool?

Draw a picture to show us!

**Which dinosaur is eating their food?
Connect the dots to find out!**

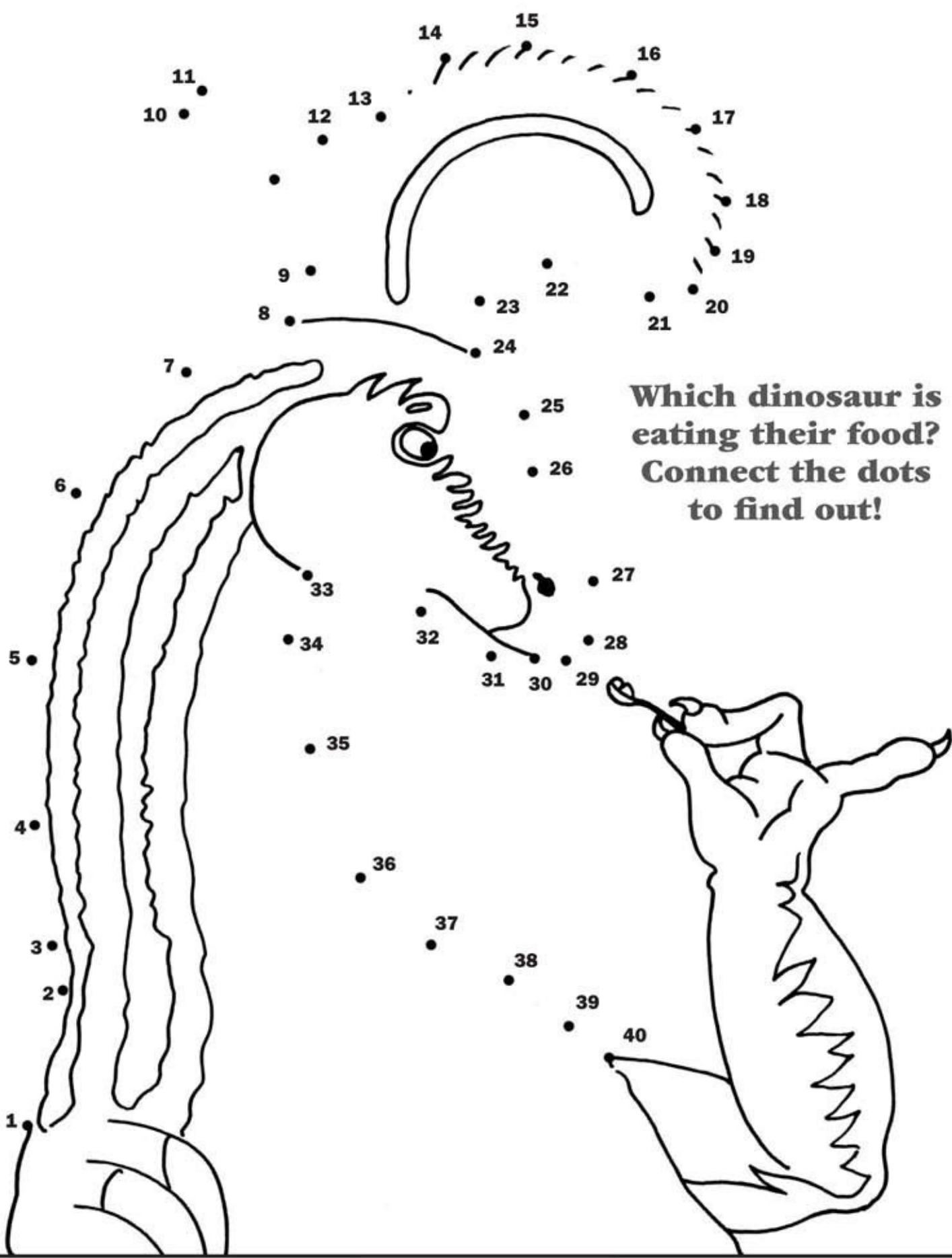

**Help this dinosaur
get well soon—make
him feel better by
coloring him in!**

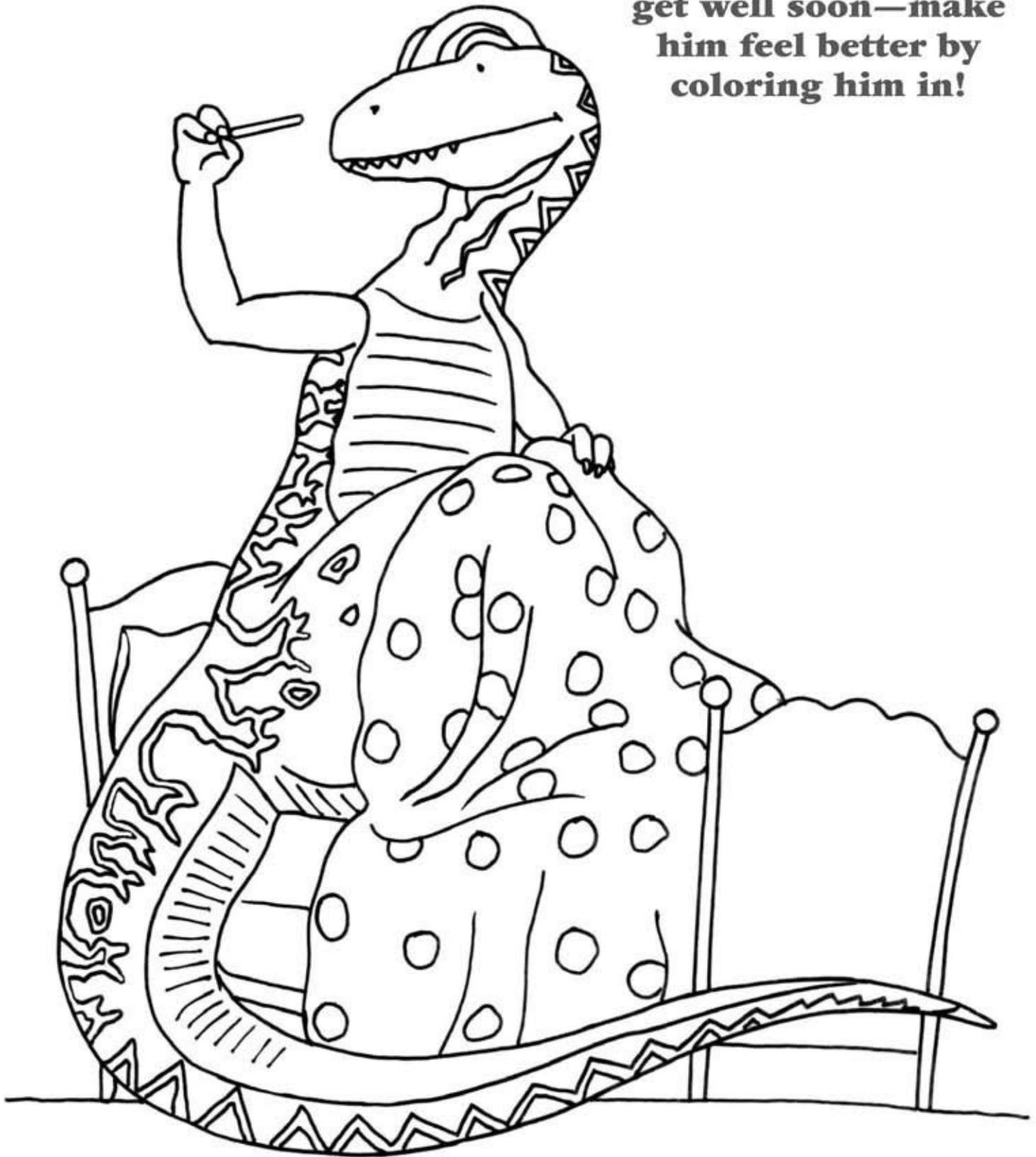

It's past this dinosaur's bedtime!

Can you help him
find his way to bed?

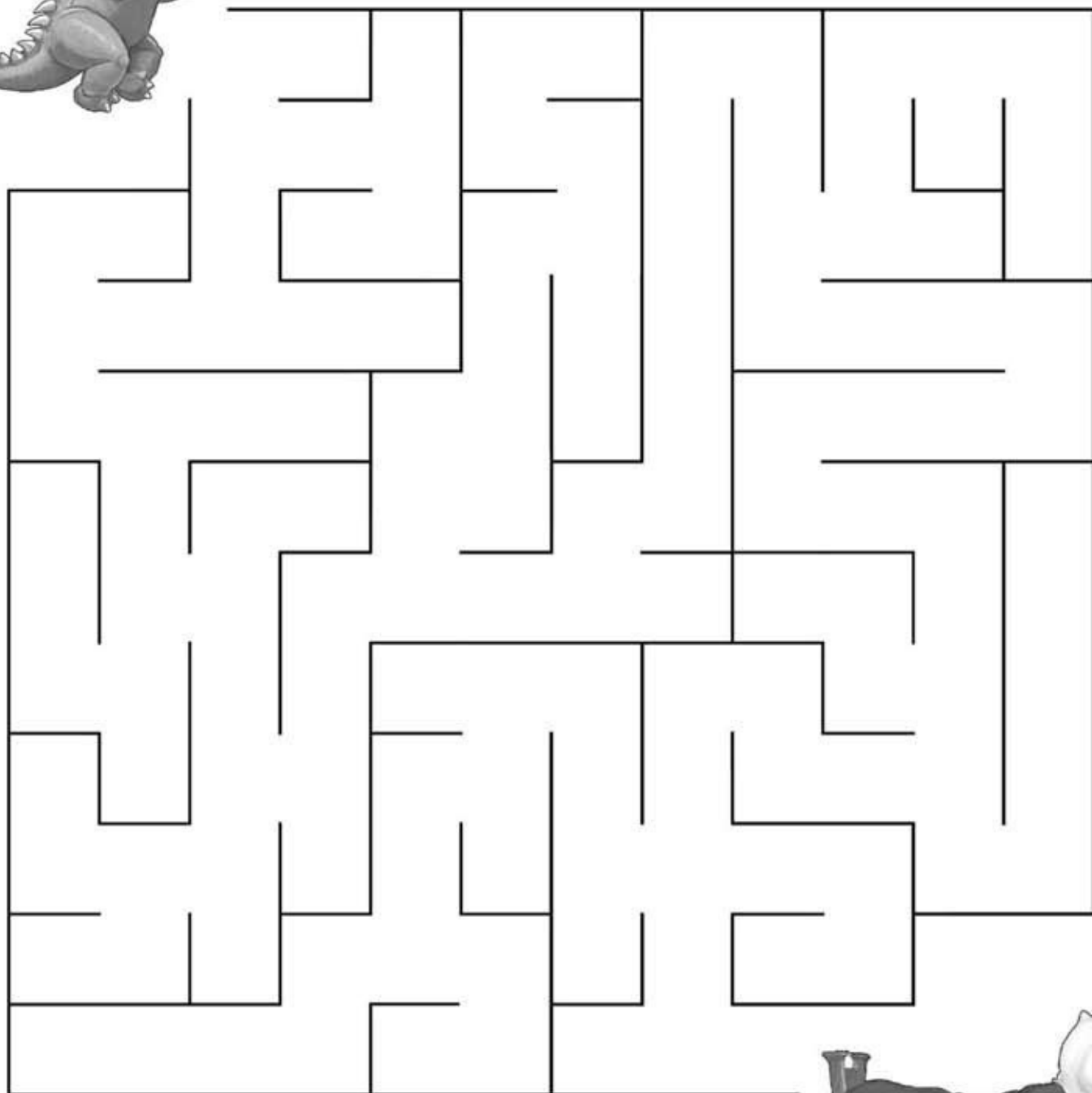

**Bird is happier when he is with his friends.
Can you help him find them?**

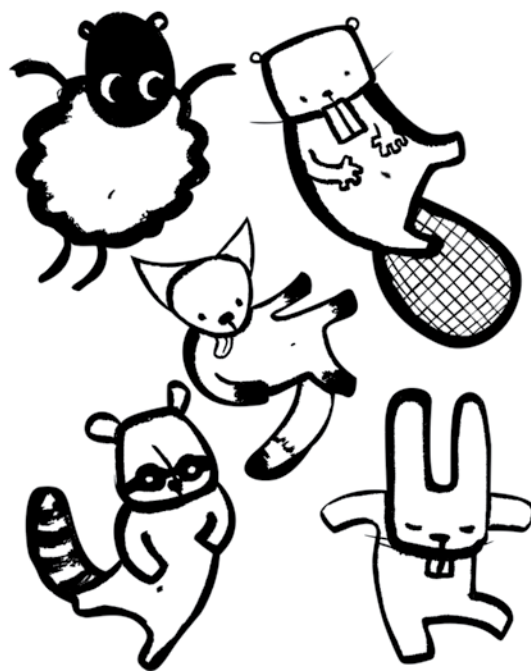
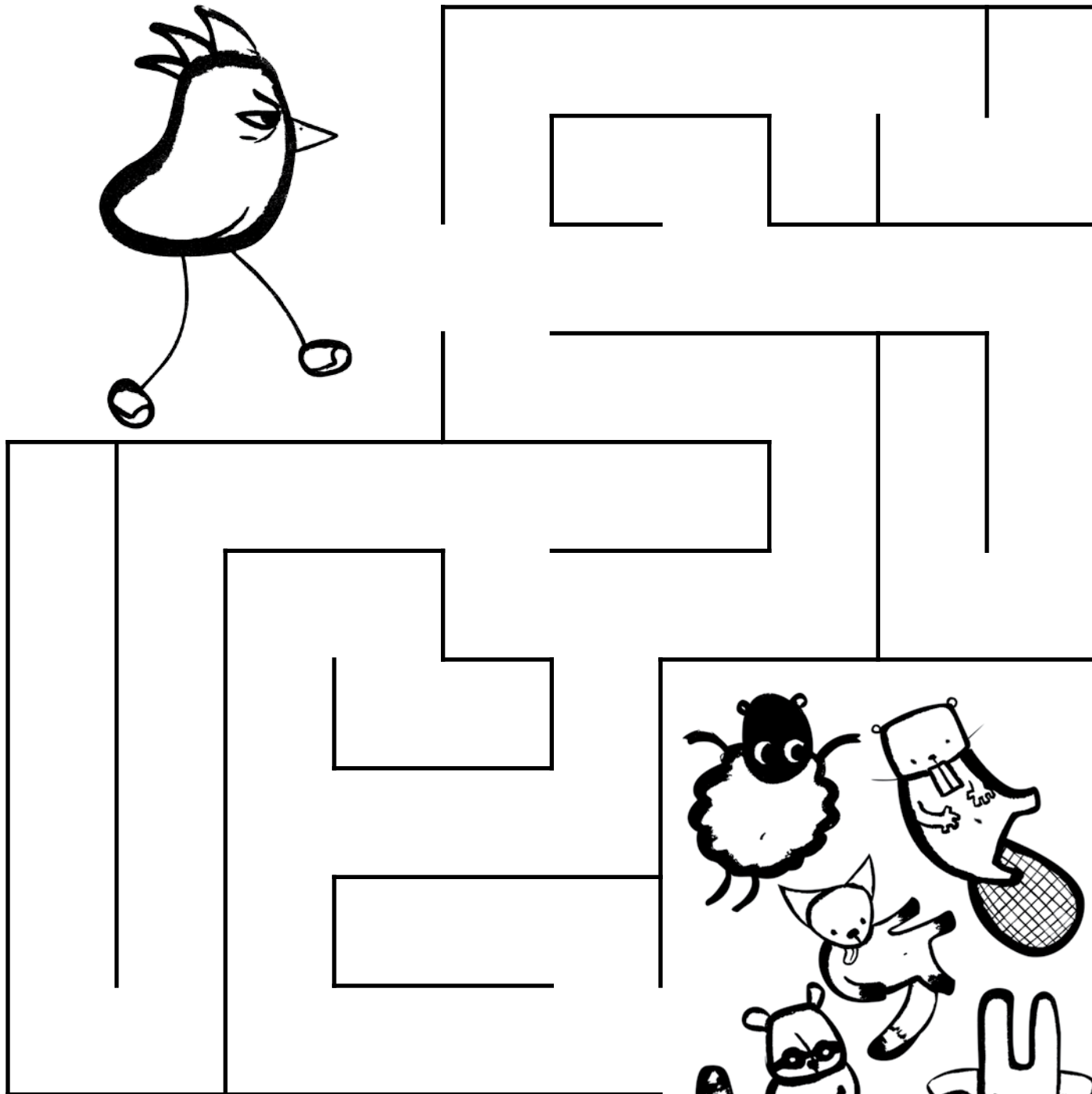

Scholastic Press

 **SCHOLASTIC**
www.scholastic.com

REPRODUCIBLE D
Maze

SCHOLASTIC and associated logos are trademarks
and/or registered trademarks of Scholastic Inc.
Art © 2007 by Jeremy Tankard.

Put on a smile and join us for **Grumpy Bird** Story Hour!

Date: _____

Time: _____

Place: _____

RSVP By: _____

Phone: _____

E-mail: _____

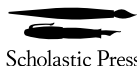

Scholastic Press

SCHOLASTIC
www.scholastic.com

SCHOLASTIC and associated logos are trademarks
and/or registered trademarks of Scholastic Inc.
Art © 2007 by Jeremy Tankard.

REPRODUCIBLE A
Announcement/Invitation

Color in Grumpy Bird and his friends!

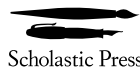
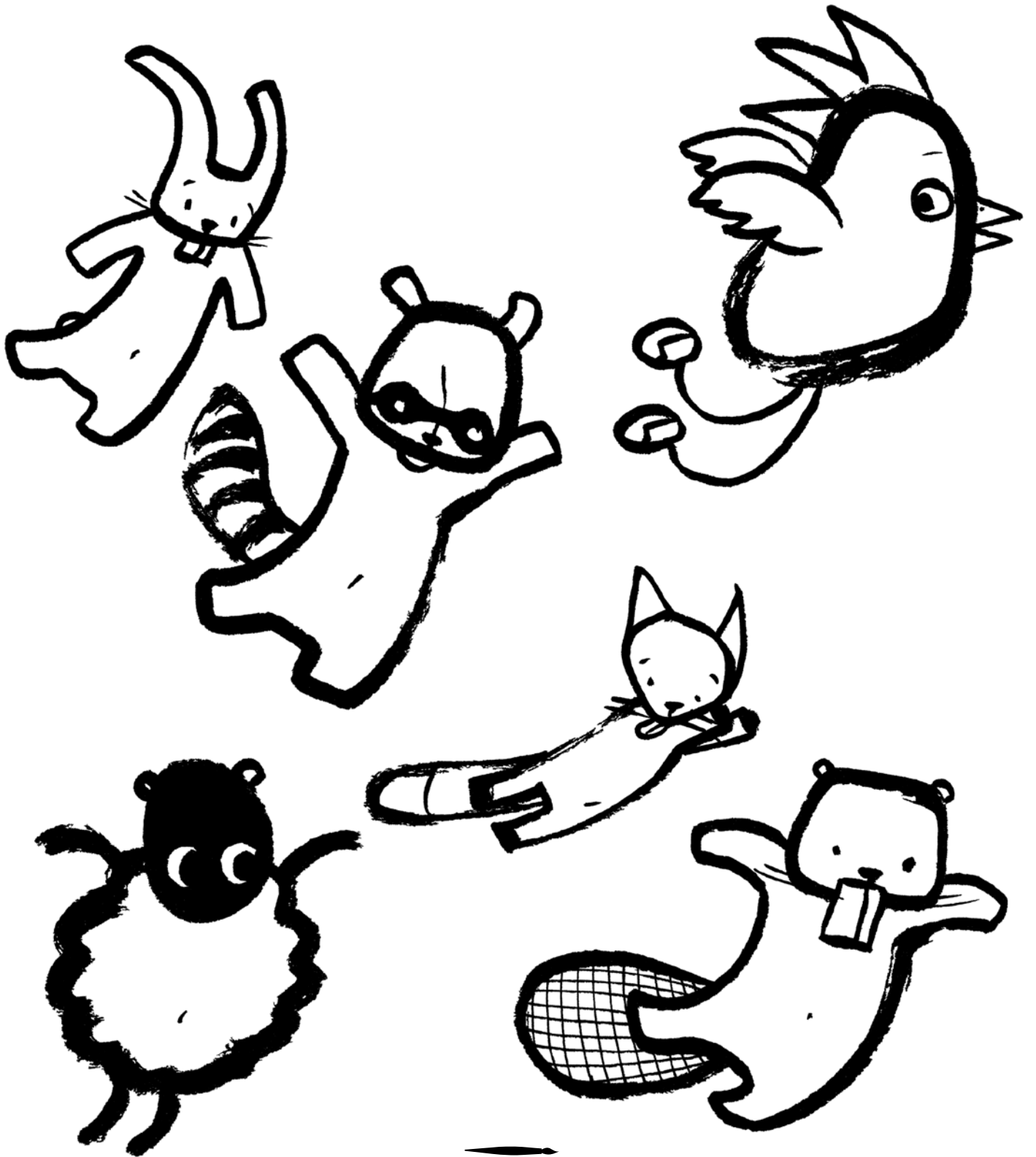

Scholastic Press

 **SCHOLASTIC**
www.scholastic.com

REPRODUCIBLE C
Coloring Sheet

SCHOLASTIC and associated logos are trademarks
and/or registered trademarks of Scholastic Inc.
Art © 2007 by Jeremy Tankard.

Help Manny choose the right path
to find Flicker, Pat, and Squeeze.



START ▶



★ FINISH



Sunday Night Oct 4 at 7pm/6c Only on Disney Channel

For more fun and games, visit

PlayhouseDisney.com/Manny



Color in Manny, the tools, and the motorcycle!



Sunday Night Oct 4 at 7pm/6c Only on Disney Channel

For more fun and games, visit

PlayhouseDisney.com/Manny



How Do Dinosaurs Clean Their Rooms?

Jane Yolen & Mark Teague

Doorknob Hanger Directions:

1. Print this page.
2. Glue it to a piece of sturdy paper or lightweight cardboard.
3. Carefully cut out the doorknob hanger.

Read them all!

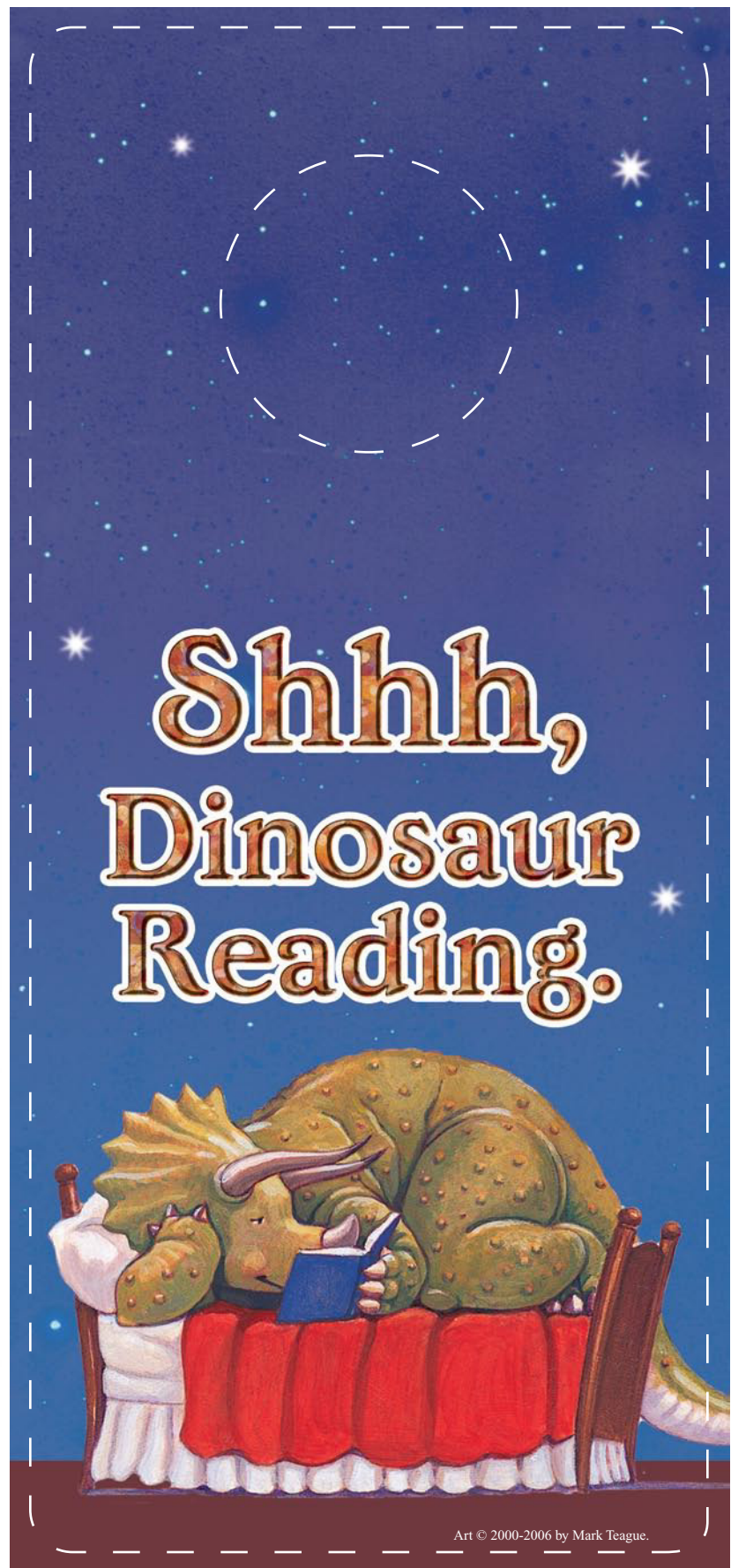

Art © 2000-2006 by Mark Teague.

www.scholastic.com

SCHOLASTIC and associated logos are trademarks and/or registered trademarks of Scholastic Inc. Art © 2000-2006 by Mark Teague.

 SCHOLASTIC

THE BLUE SKY PRESS



How Do Dinosaurs Clean Their Rooms?

Jane Yolen & Mark Teague

Can you help this dinosaur put his clothes in the basket?

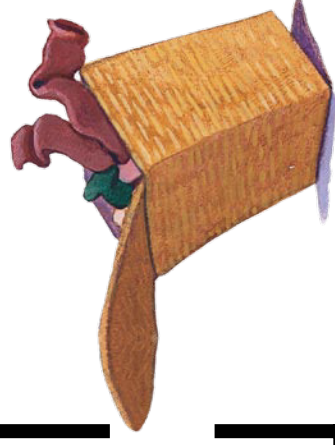
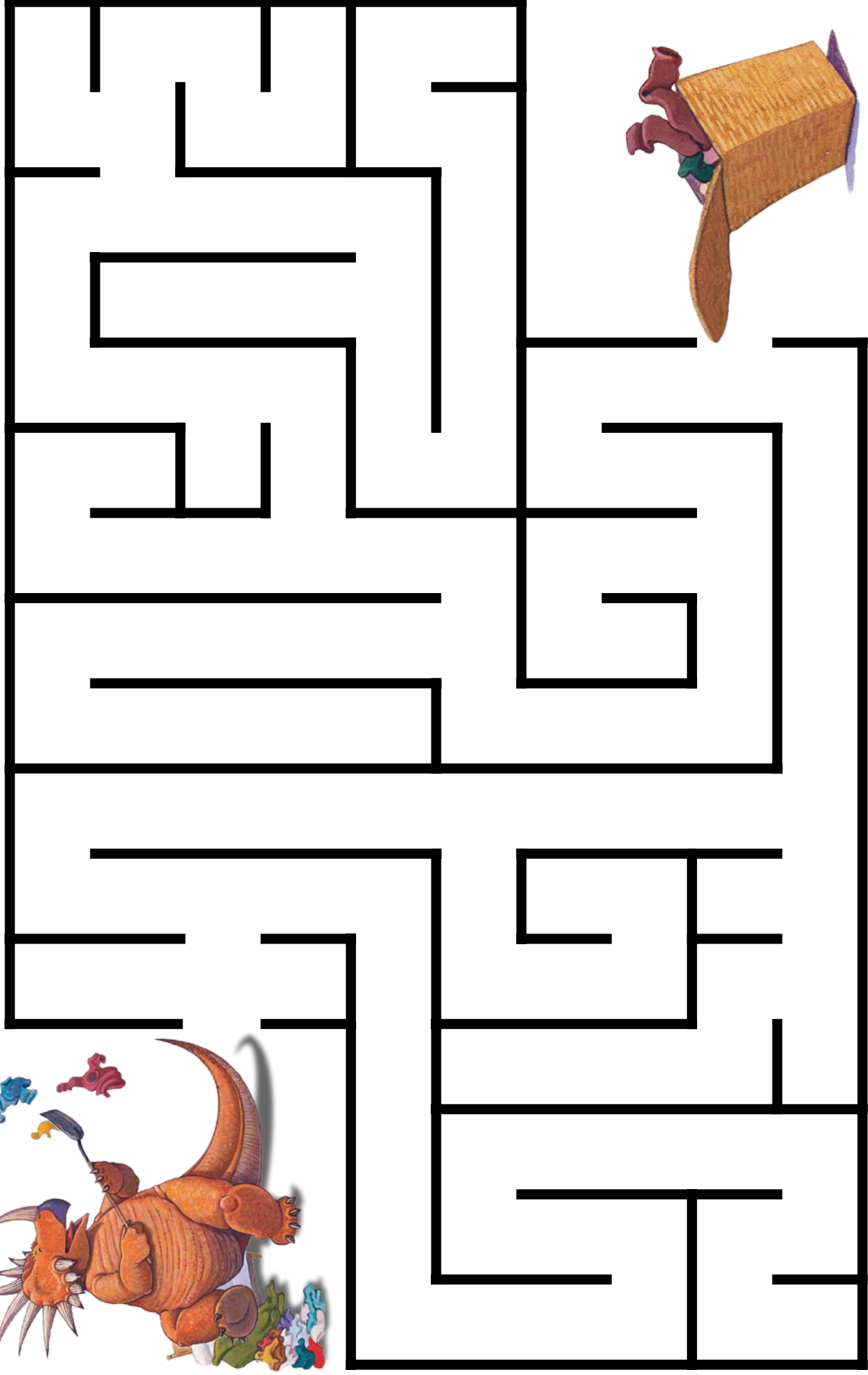

www.scholastic.com



SCHOLASTIC and associated logos are trademarks and/or registered trademarks of Scholastic Inc. Art © 2000-2006 by Mark Teague.

THE BLUE SKY PRESS 

How Do Dinosaurs Clean Their Rooms?

Jane Yolen & Mark Teague

Have fun and color in the dinosaur and his room.

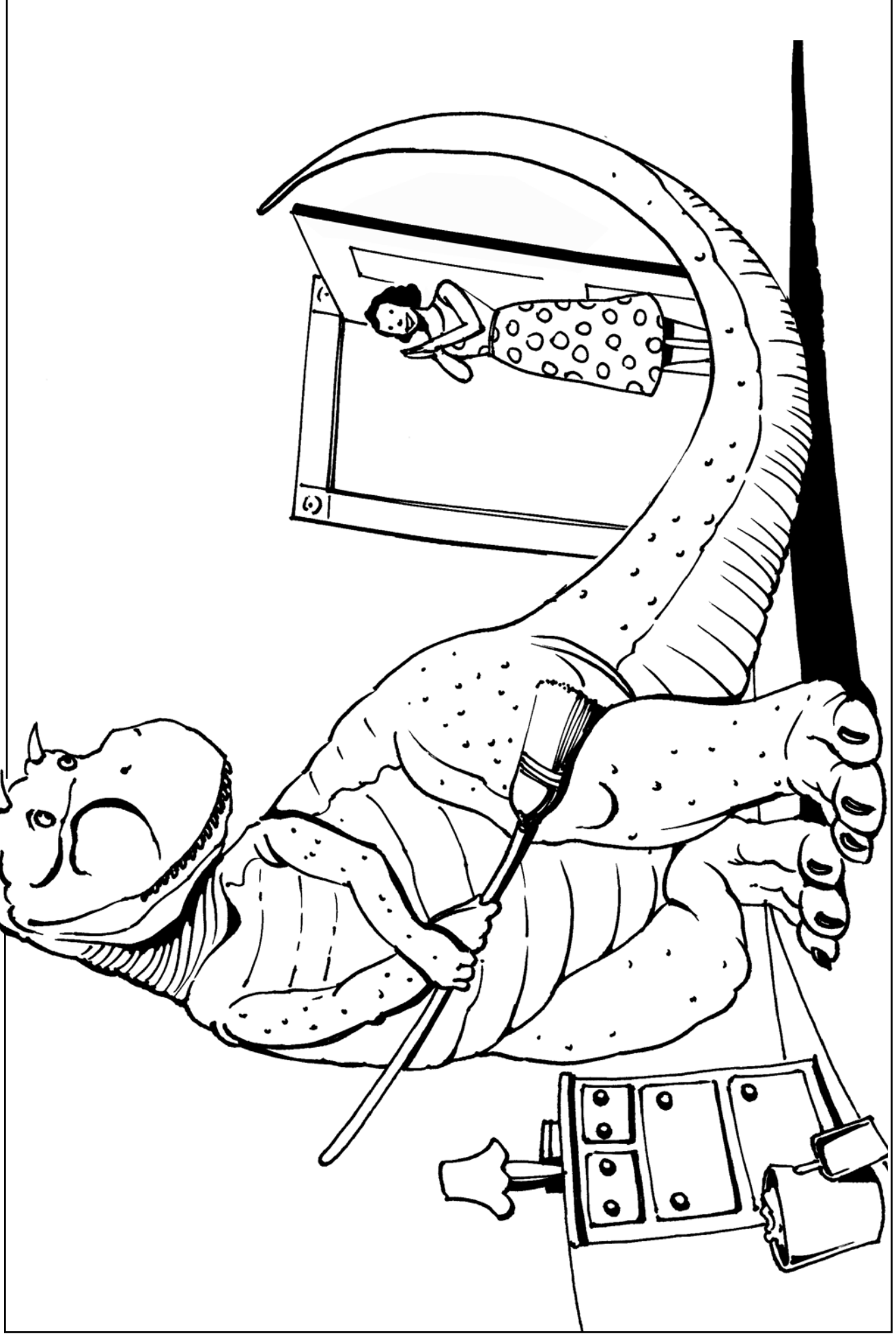

www.scholastic.com

 SCHOLASTIC

SCHOLASTIC and associated logos are trademarks and/or registered trademarks of Scholastic Inc. Art © 2000-2006 by Mark Teague.

THE BLUE SKY PRESS 

SAIL AWAY WITH SEYMOUR

IN YOUR OWN JUICE BOX BOAT

TO BUILD YOUR BOAT, YOU MUST FIRST
FIND A PIECE OF PAPER

THEN, FIND A SIPPING
STRAW THAT BENDS

AND ONE
JUICE CARTON

NOW YOU'RE READY TO BEGIN!

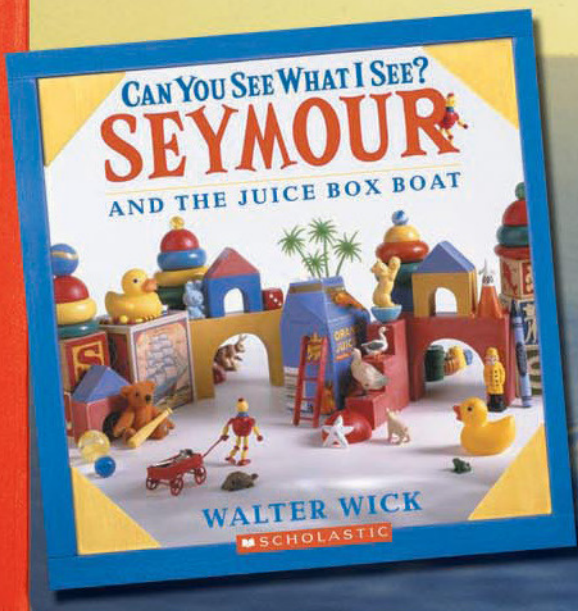

What you need

- 1 A sheet of paper
- 2 A bendy straw
- 3 An 8-ounce orange juice carton or milk carton
- 4 A pair of safety scissors
- 5 A roll of tape

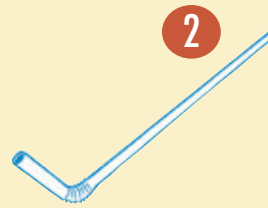
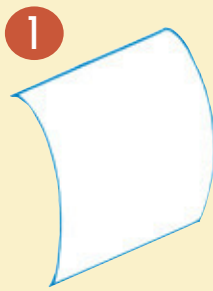

What to do

1. Wash your carton thoroughly.
2. Carefully cut along dotted lines.
Shown in diagram A.
3. Poke a hole in the side of your carton with a pencil. Shown in diagram B.
If you need help, ask a parent or a teacher.

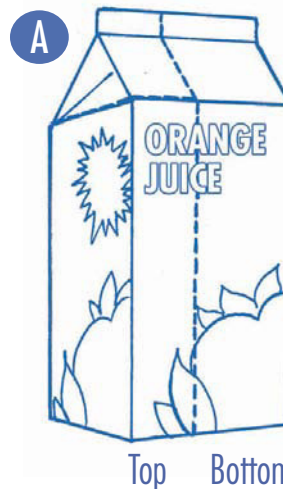

Cut off the top third of the carton.

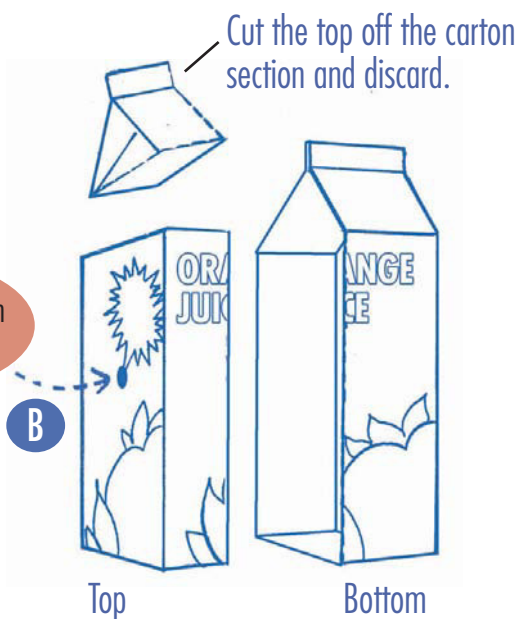

Make a hole in carton to hold mast.

Cut the top off the carton section and discard.

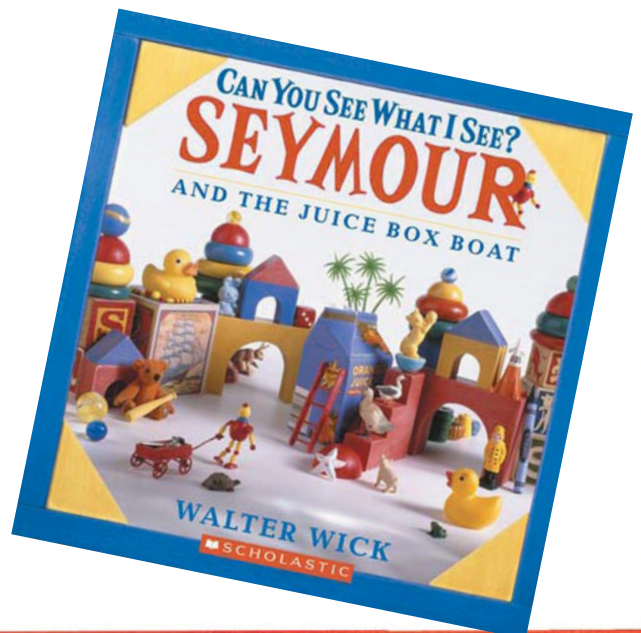

What to do

4. Insert the straw into the hole with the bendy part at the bottom. Trim the straw as needed to allow the short section of the straw to fit inside the boat. Shown in diagram C.
5. Begin to slide top section into the bottom section. Shown in diagram D. Before completely fitting straw/carton section assembly into the base, tape the straw to the bottom of the boat. Shown in diagram E. Top section should fit snugly without the need for tape or glue.
6. Make your paper sail about 4 inches wide and 5 inches tall. Poke holes for the mast slide it over the straw. Shown in diagram F.
7. Decorate your boat however you want to.
8. You're finished! Your new boat will float in the water and skim along the surface if you blow on the sail.

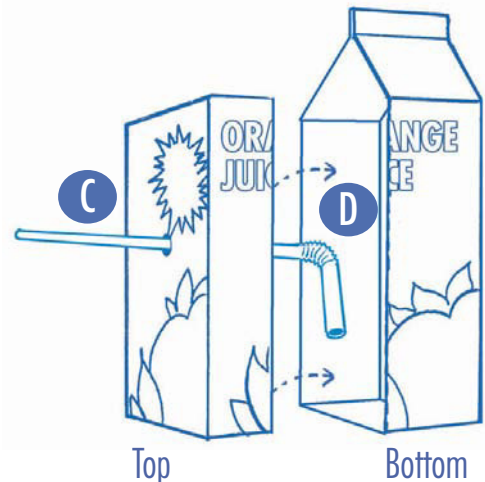

Insert smaller section of box into larger section.

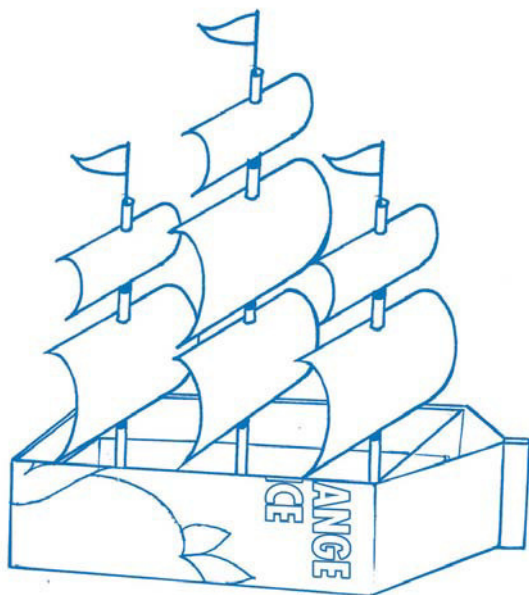
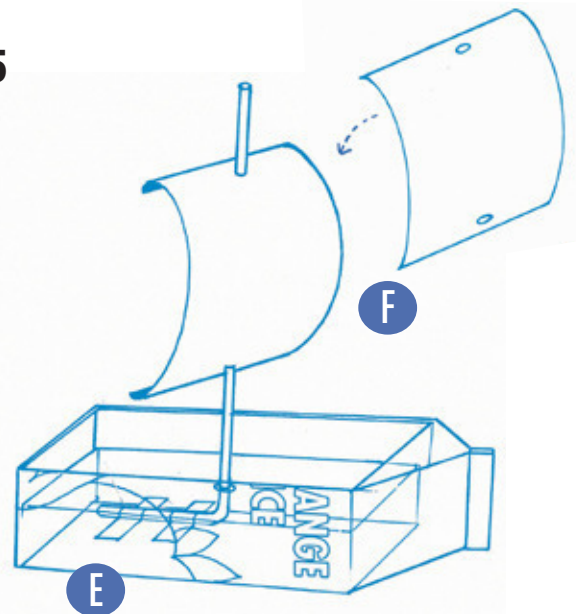

Don't Forget

Advanced boat builders can make a three-masted ship by using a 32-ounce carton, 3 straws, and 3 sails.

CAN YOU SEE WHAT I SEE?

The Letter Game

Chose a letter and fill in this sheet with as many things as you can see that begin with that letter. Who can find the most things? Who found something no one else did?

Letter: _____

1. _____ 6. _____

2. _____ 7. _____

3. _____ 8. _____

4. _____ 9. _____

5. _____ 10. _____

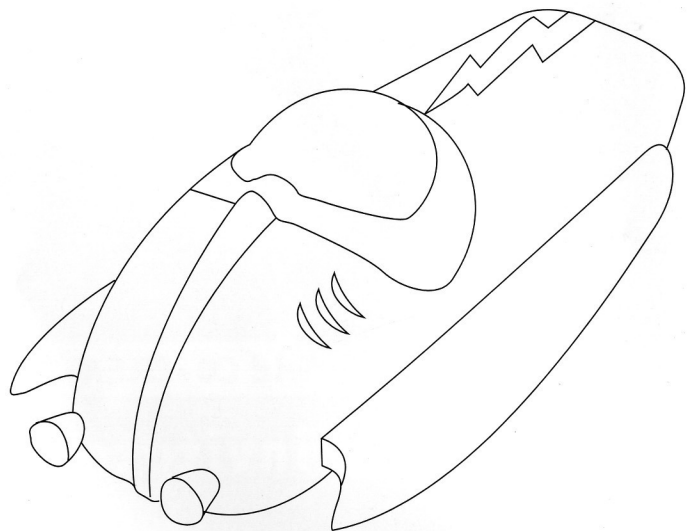
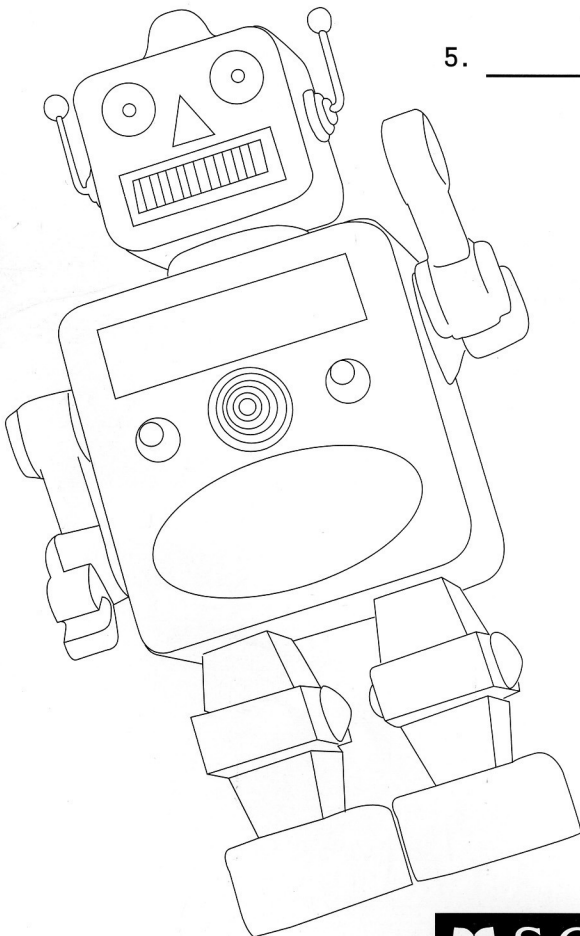

Reproducible B

 **SCHOLASTIC**

SCHOLASTIC and associated logos are trademarks and/or registered trademarks of Scholastic Inc.





Maya & Miguel Rainy Day Fun Maze

Abuela has made a tasty meal. Help Maya & Miguel find their way home for lunch.

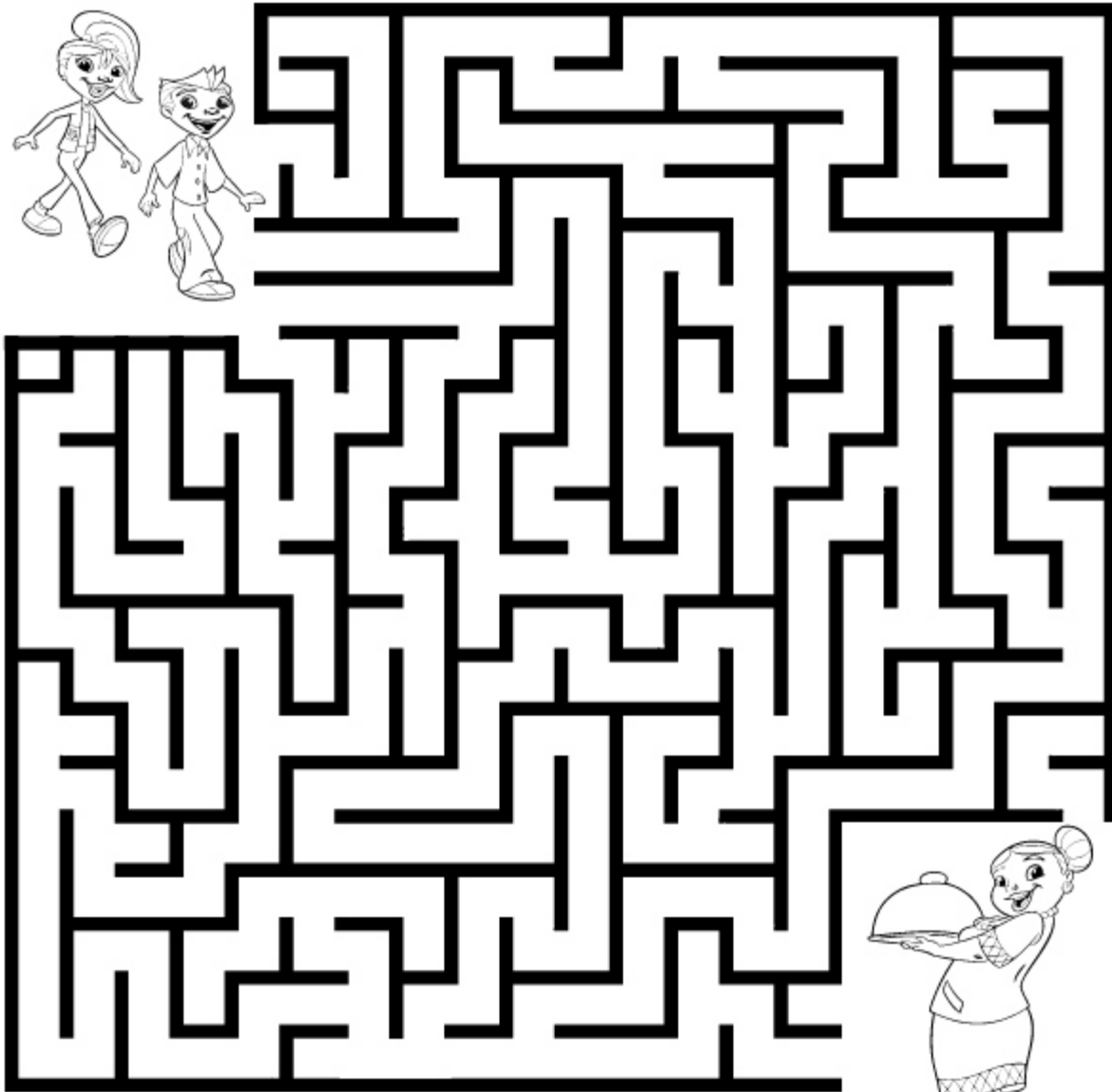

 SCHOLASTIC

www.scholastic.com

Scholastic, MAYA & MIGUEL and logos are trademarks of Scholastic, Inc.

< BACK

**Mickey Mouse Clubhouse
Choo-Choo Express
Doorknob Hanger
Directions:**

- 1. Print this page.**
- 2. Glue it to a piece of sturdy paper or lightweight cardboard.**
- 3. Have an adult cut along the dotted lines.**

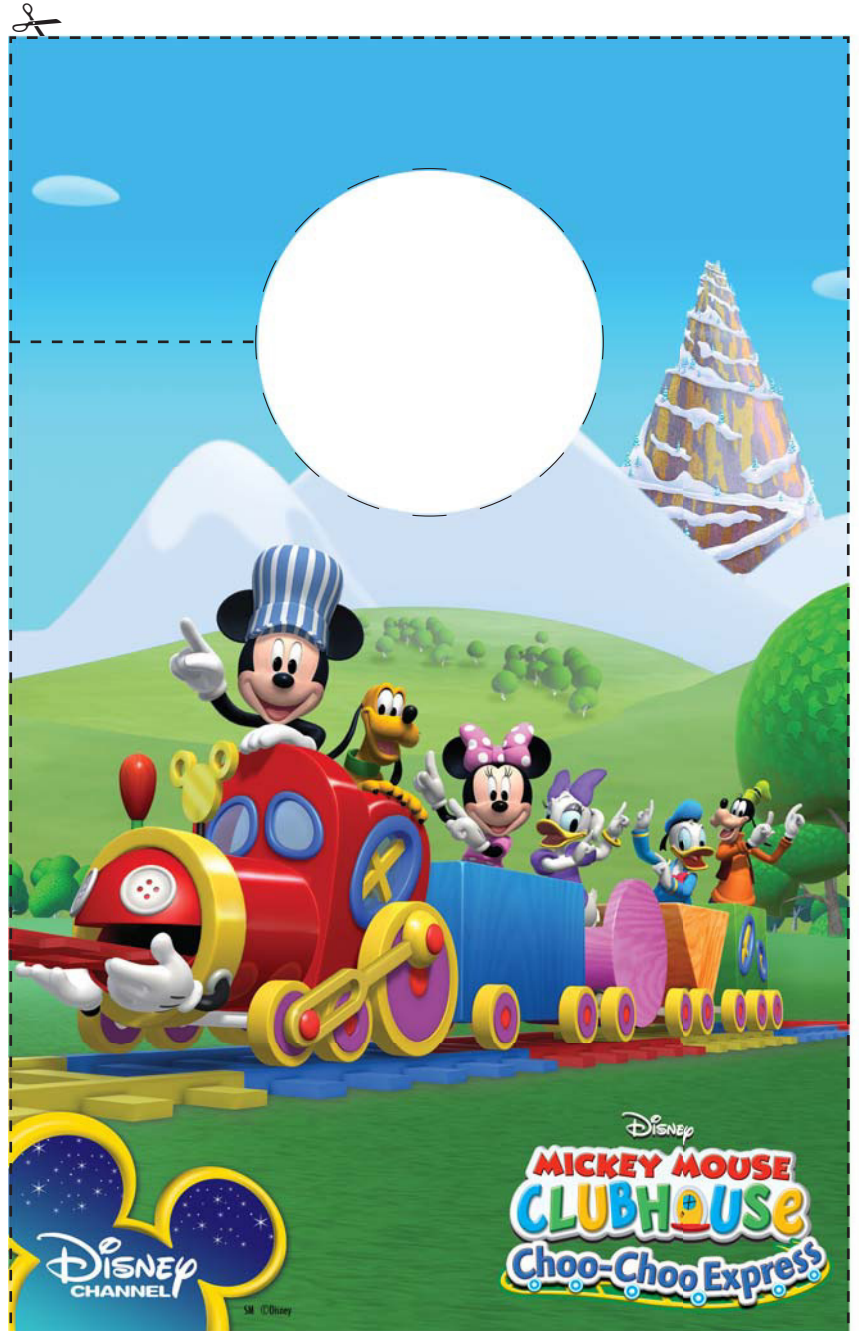

'S ROOM

For more fun and games, visit
PlayhouseDisney.com/MickeyMouseClubhouse



Sunday Night Oct 25 at 7pm/6c Only on Disney Channel

For more fun and games, visit
PlayhouseDisney.com/MickeyMouseClubhouse





GUESS WHO?



MAYA & MIGUEL and logos are trademarks of Scholastic Inc.
© 2004 Scholastic Entertainment Inc. All rights reserved.

< BACK

Rhyme Time

Write your own riddle!

Using a page from the book, write your own riddle that starts with *CAN YOU SEE WHAT I SEE?* Make sure that every other line rhymes, too. That's the tricky part.

Your name: _____

Name of the puzzle: _____

CAN YOU SEE WHAT I SEE? _____

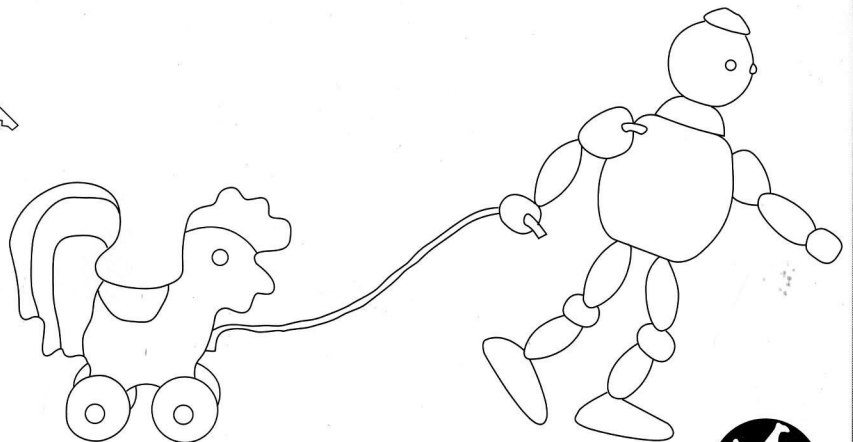
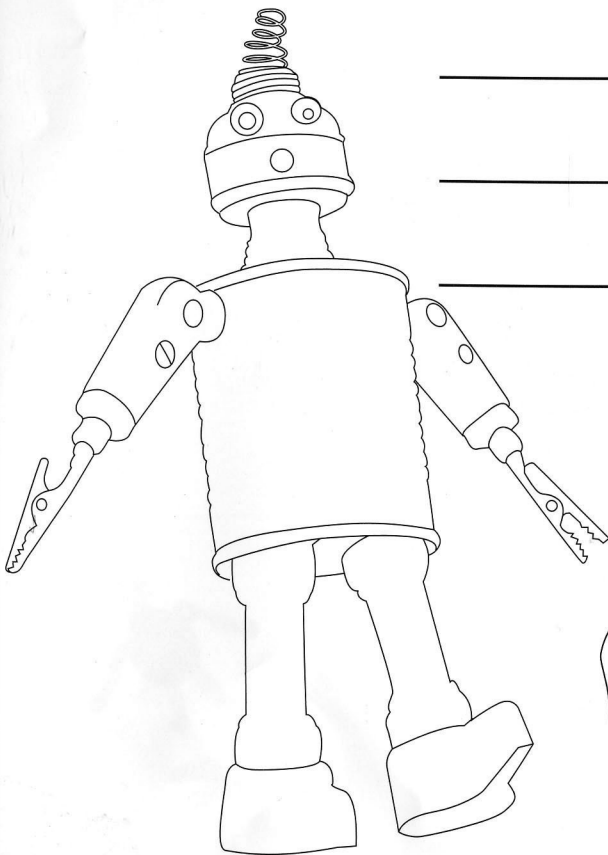



First Day of School

Fill in the blanks

In *Brand New School, Brave New Ruby*, Ruby is starting the third grade in a new school. Morning time is happy time for Ruby. Fill in the blanks and write your own morning story.

I wake up at _____ o'clock, and brush my _____. I get
(time) (body part)

my _____ out of the closet, and start to _____.
(article of clothing) (something to do)

My bed is usually a mess, so I _____ and put my favorite
(something to do)

_____ on top of it. In the kitchen, my _____ is
(thing or things) (family member)

making breakfast. I absolutely love _____ with _____.
(food) (food)

and eat it almost every day. To get to school, I _____.
(mode of transportation)

Everyone meets in my classroom, and then _____ begins. My
(class)

teacher is happy when we all _____. At recess, my
(something to do)

BFF and I like to _____ together. Lunch time is fun time,
(something to do)

because _____ and I sit together and _____ while
(friend) (something to do)

we eat our lunches. Morning is over, but tomorrow I get to do it all again!



www.scholastic.com



Reproducible C

School Supplies Word Search

Ruby is starting third grade in a brand-new school and needs lots of supplies.
Can you help by finding the items on her list below in this word search?

T	T	D	N	J	O	L	I	C	N	E	P	O	I	P	O
I	H	J	I	F	Y	C	F	R	X	T	Q	U	B	V	O
B	N	B	S	B	E	H	O	V	L	J	J	L	O	B	R
S	S	O	Y	J	B	S	S	M	W	U	O	F	A	Q	U
H	H	H	T	H	S	L	F	D	P	O	W	S	C	S	E
A	A	S	R	E	Z	F	T	D	U	A	A	R	R	T	M
R	I	C	G	V	B	K	A	J	T	V	S	G	N	A	V
K	S	C	I	S	S	O	R	S	W	R	I	S	V	P	A
Z	Z	O	U	M	B	L	O	H	E	B	L	L	X	L	Q
H	H	V	T	E	L	B	R	K	L	I	O	G	O	E	M
R	X	N	S	Y	R	D	R	S	U	L	C	Z	B	R	H
E	E	P	A	T	H	A	H	I	B	M	N	S	O	H	E
L	Q	I	T	R	M	H	S	C	U	L	T	H	T	B	L
U	P	S	D	K	N	P	E	I	G	L	U	E	X	E	Y
R	M	A	Y	W	F	N	O	M	Y	Y	S	I	O	P	A
M	R	U	S	T	A	P	O	M	Z	C	H	U	R	T	V



- | | | | | |
|----------|----------|---------|------|---------|
| Pencil | Notebook | Ruler | Glue | Markers |
| Scissors | Compass | Stapler | Tape | |



Lunch Scramble Supreme!

Ruby meets her BFF Teresa Petticoat every day for lunch in the cafeteria. Can you unscramble the words below and then fill in the letters that go with the numbers to discover Ruby's coded message to Teresa? Hint: all the words are things you can find in a lunch box.

CIEJU OBX

2							

RMSEHOT

7						

ERSGPA

6					

PAPLE

1				

ANNBAA

--	--	--	--	--	--

WDICSANH

4							

SHPCI

--	--	--	--	--

RTOSACR

3						

KPANIN

--	--	--	--	--	--

SECOKOI

5						

LIK M

--	--	--	--

1	2	3	4

5	6	7

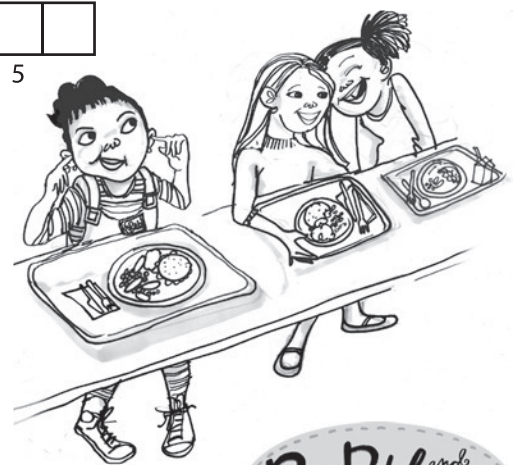

Answer Key

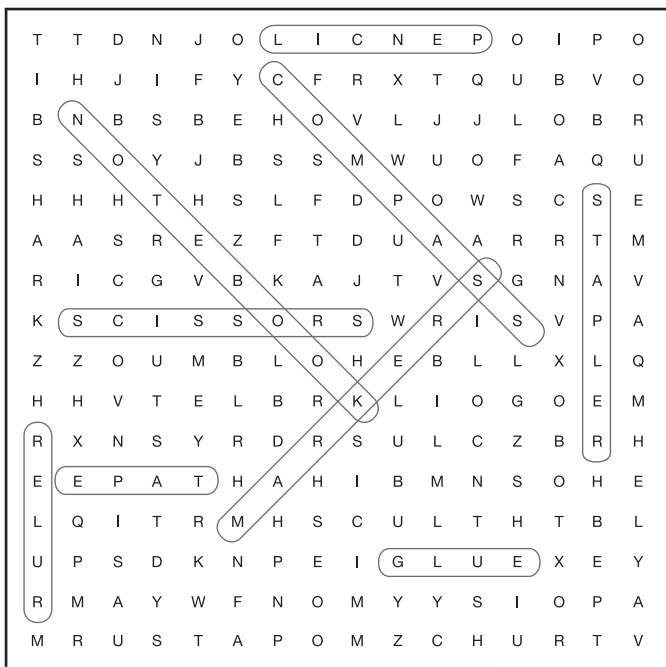

Answer Key
Reproducible B:
Word Search



CIEUX JBO

J U I C E B O X
2

RMSEHOT

T H E R M O S
7

ERSGPA

G R A P E S
6

PAPLE

A P P L E
1

ANNBAA

B A N A N A

WDICSANH

S A N D W I C H
4

SHPCI

C H I P S

RTOSACR

C A R R O T S
3

KPANIN

N A P K I N

SECOKOI

C O O K I E S
5

LIK M

M I L K

L E T ' S
1 2 3 4

E A T !
5 6 7

Answer Key
Reproducible D
Unscramble

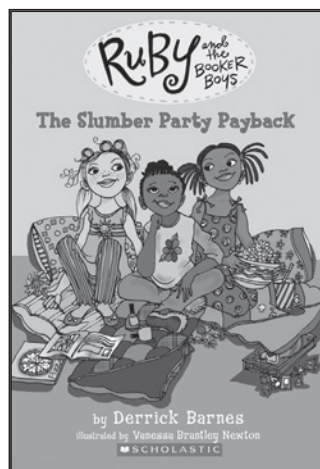
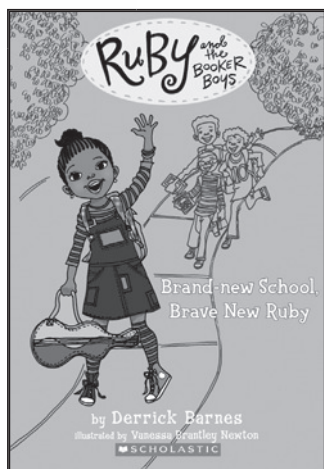
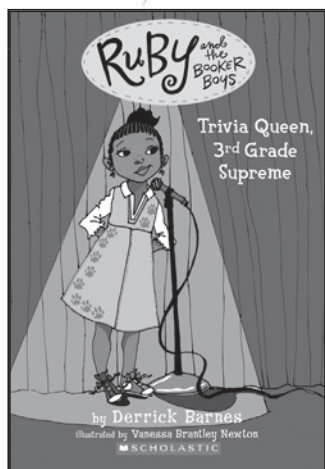

Read about all of Ruby's adventures in the **Ruby and the Booker Boys** series by Derrick Barnes.



www.scholastic.com



Reproducible A