

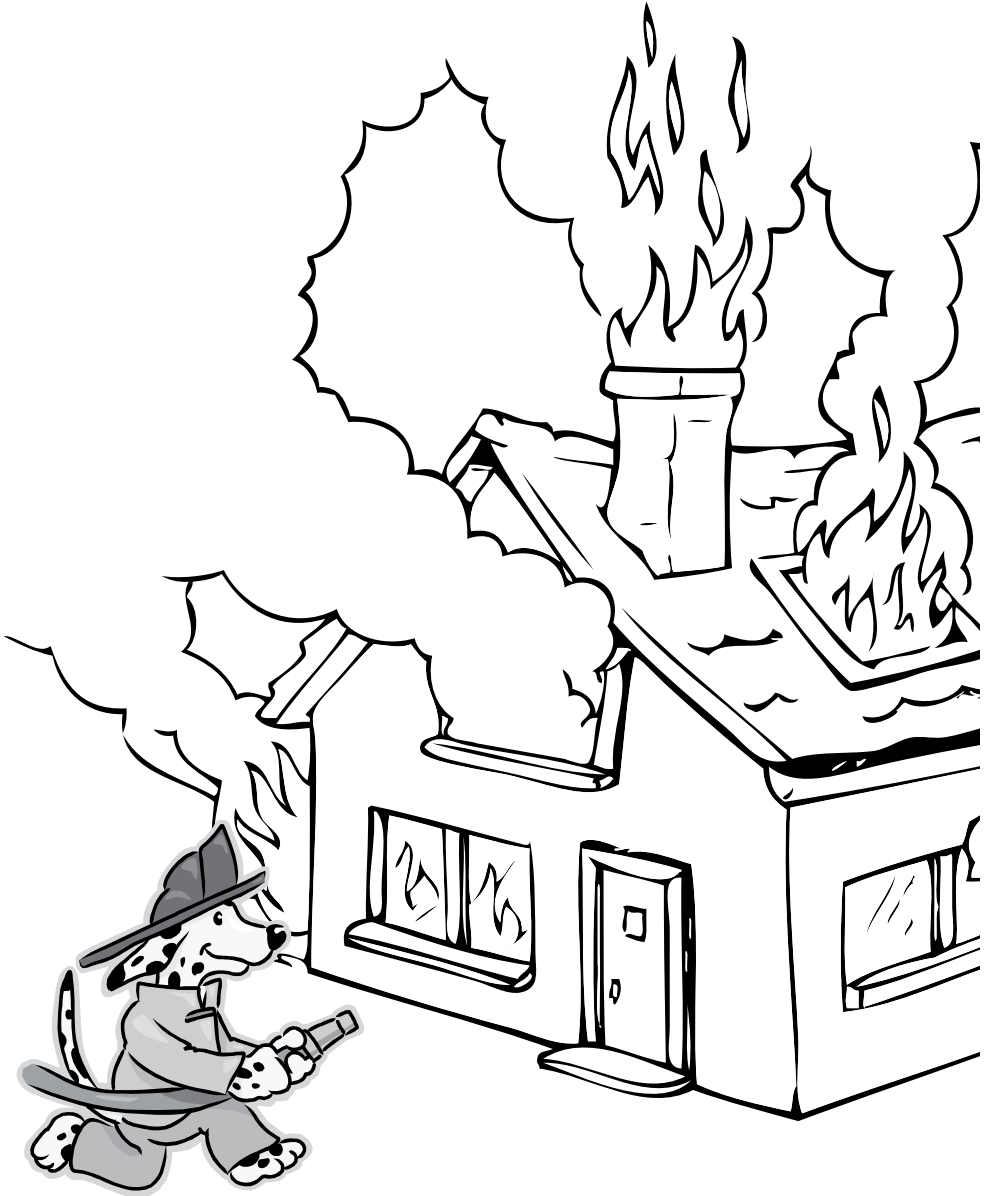

Plan, Prepare and Practice Fire Safety!



Find the Fire Helmets

How many  can you find in the picture below?

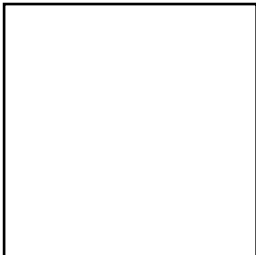

Answers on pg 18

Fire Safety Tips

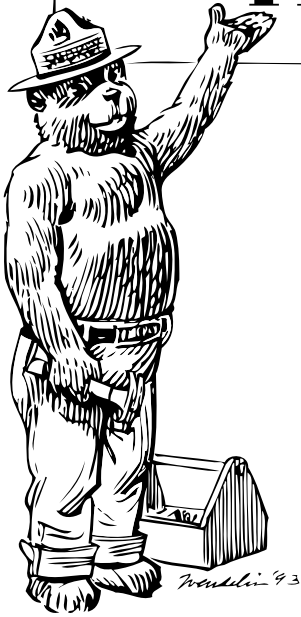

- ✓ Stay away from hot objects
- ✓ Never play with matches, lighters, or candles
- ✓ Have at least one smoke alarm per level in your house
- ✓ Test smoke alarms once a month
- ✓ Change batteries in smoke alarms every six months
- ✓ Create and **Practice** an **Escape Plan** in case of a fire at your house
- ✓ If there is a fire in your house, leave as fast as you can, **do not stop to pick up toys**
- ✓ If there is a fire in your house always test the door to see if it is hot, if it is, **leave through the window**
- ✓ Always crawl under smoke
- ✓ If your clothing or hair catches on fire, **STOP, DROP and ROLL**

What do Firefighter's Need?

Find all of the words and circle them to help firefighter Tom gather his safety equipment and tools so he can be prepared for an emergency.



T	J	B	P	B	O	O	T	S	C	E	T
U	O	A	M	I	N	G	E	B	R	D	U
R	N	D	A	L	N	I	A	H	G	H	R
N	I	G	M	A	S	K	M	Q	F	E	N
O	B	E	C	D	C	O	P	A	S	L	O
U	W	A	T	D	B	O	O	L	X	M	U
T	F	I	R	E	E	N	G	I	N	E	T
P	A	N	I	R	Y	J	N	T	W	T	C
A	T	U	R	N	O	P	U	K	M	L	O
N	E	G	L	O	V	E	S	R	E	T	A
T	F	I	R	S	T	A	I	D	K	I	T
S	D	W	A	T	E	R	H	O	S	E	Y

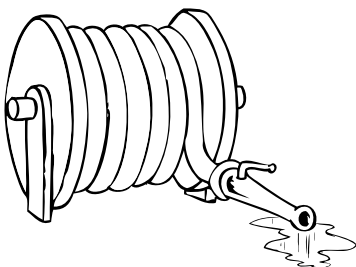

Badge
Boots
Fire Engine
First Aid Kit
Gloves
Helmet

Ladder
Mask
Team
Turnout Coat
Turnout Pants
Water Hose

Answers on pg 18

Help Firefighter Kim!



START

Help Firefighter Kim by giving her directions to the burning house, beware, there is a lot of construction going on.

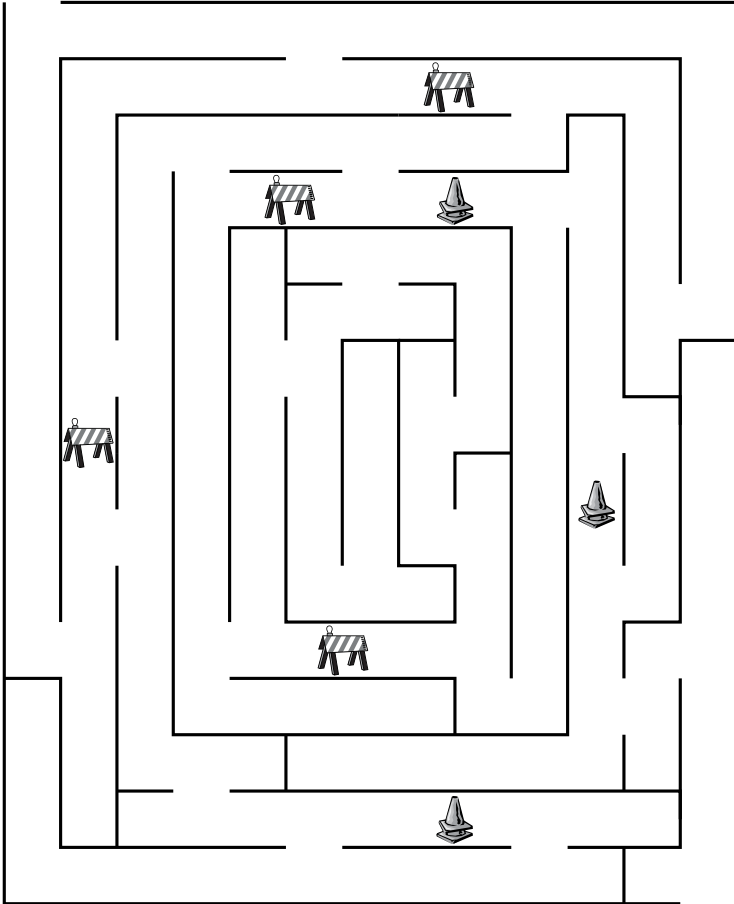

Fire Safety Crossword

Fill in the Crossword Puzzle to see how much you know about fire safety!

Across

1. Everyone should _____ their fire escape plan
3. Everyone should have at least one in their home
5. What a firefighter wears to protect their head
7. Stop, Drop and _____
9. The Fire Prevention Bear
11. A Firefighter drives a fire _____ to fires
13. People who are called to fight fires
16. The Fire Dog
17. _____ play with matches
21. Firefighters can get water from fire _____ in cities
22. _____, drop and roll

Down

2. Everyone should make an _____ in case of a fire in their home
4. Tool used to spray water
6. Fire _____ can be used to help put out a fire inside
8. _____ Department of Forestry and Fire Protection is the state's fire department
10. 9-1-_____
12. This is dangerous when not in a controlled environment
14. Allows firefighters to access high places
15. Only _____ can prevent forest fires
18. If you see a _____, tell an adult
19. Stop, _____ and Roll
20. To report an emergency you dial _____-1-1

Some words may be used more than once

Boots	Firefighter	Matches	Smokey
California	Forest	Nine	Sparky
Drop	Gloves	Never	State
Engine	Helmet	One	Stop
Escape Plane	Hose	Practice	Water
Extinguisher	Hydrants	Roll	Wildfire
Fire	Ladder	Smoke Alarm	You

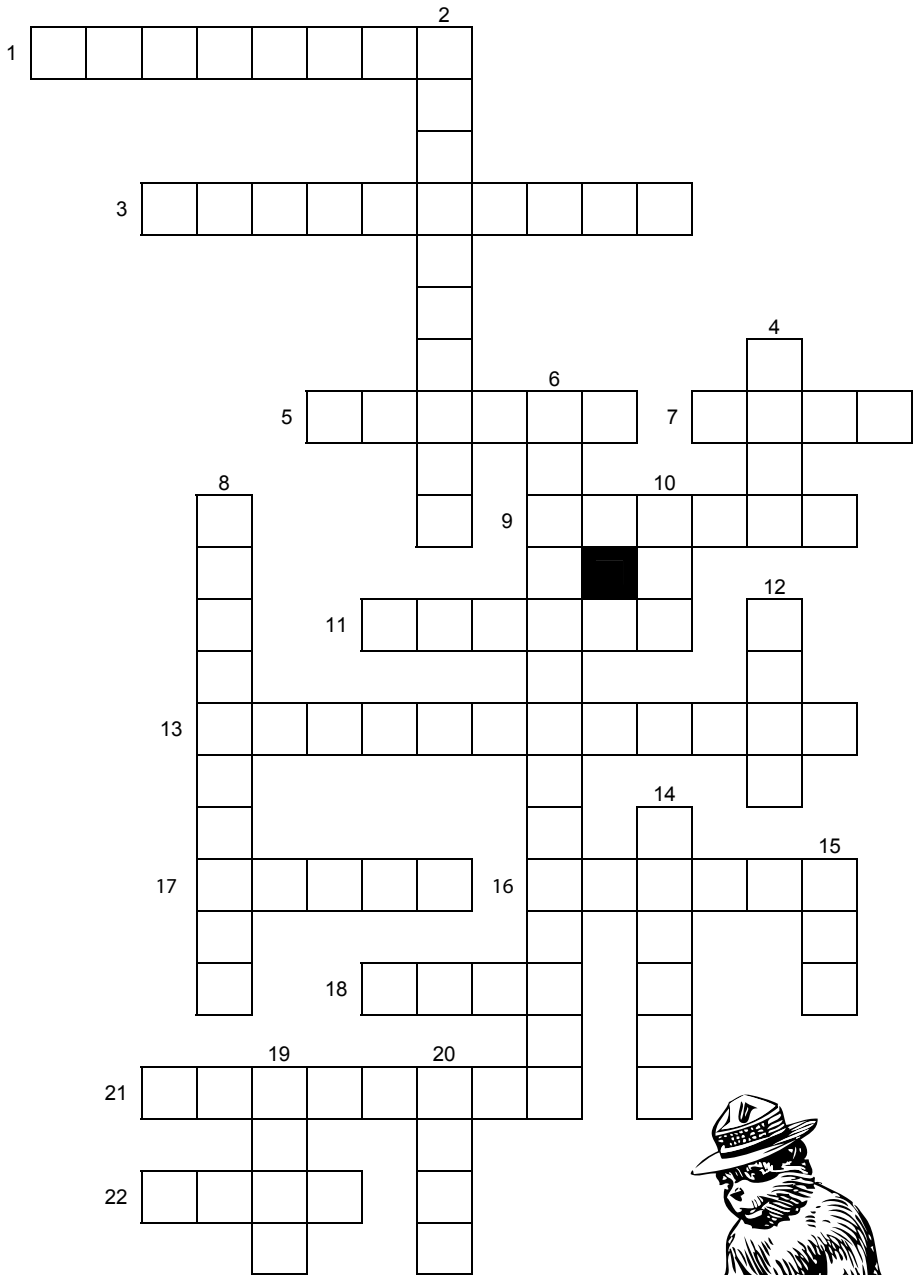

Answers on pg 18

SMOKEY 'S SECRET MESSAGE

Use the letter key to uncode Smokey's Message.

A	B	C	D	E	F	G	H	I	J	K	L	M
2	4	6	8	10	12	14	16	18	20	22	24	26

N	O	P	Q	R	S	T	U	V	W	X	Y	Z
25	23	21	19	17	15	13	11	9	7	5	3	1

23 25 24 3 3 23 11 6 2 25
 21 17 10 9 10 25 13 12 23 17 10 15 13

_____ !
 12 18 17 10 15



Answers on pg 18

Richard M. Wenderlin '93

Fire Safety Word Search



Find all of the words and circle them

A	D	F	M	T	H	W	Q	P	N	G	Y	E	S	Y
B	I	B	I	O	E	Y	A	A	L	E	Z	N	M	E
O	C	N	S	R	K	M	L	T	A	E	S	O	O	K
O	M	E	R	R	E	P	L	P	E	T	H	E	K	O
T	T	T	A	O	E	E	R	E	O	R	C	N	E	M
S	K	P	W	P	F	A	N	P	H	U	Z	O	A	S
V	S	P	A	Z	C	I	D	G	V	K	S	E	L	K
H	V	C	Q	T	L	R	L	W	I	B	J	N	A	S
H	S	S	I	S	O	C	I	A	C	N	J	I	R	A
E	B	C	V	P	V	U	D	W	C	D	E	N	M	M
R	E	G	R	E	T	H	G	I	F	E	R	I	F	N
N	W	O	F	I	R	E	S	A	F	E	T	Y	Y	Y
Z	L	E	R	I	F	L	A	C	L	A	D	D	E	R
L	S	F	A	J	T	T	A	E	H	N	C	J	N	G
Y	C	V	C	C	N	A	E	I	Y	R	S	K	O	L

Boots

CAL FIRE

California

Escape Plan

Fire Engine

Firefighter

Fire Safety

Heat

Helmet

Help

Hose

Ladder

Mask

Nine One One

Practice

Smoke Alarm

Smokey

Sparky

Stop Drop Roll

Water

Answers on pg 19

Be Fire Safe at Home, Remember the Steps

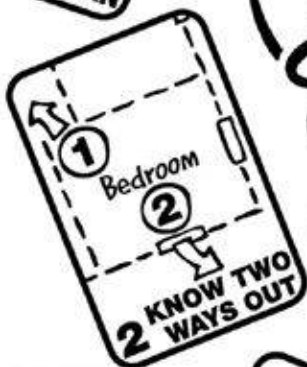

Note: Sparky's helmet and coat are always yellow with red stripes!®



How to Design Your

Fire Escape Plan

To design your own fire escape plan, sketch the floor plan of your home on a piece of paper. Indicate on the plan all doors, windows and other areas from which you could escape from each room in your home. Draw arrows to indicate the normal exits which would be your primary escape route. With an alternate color, draw arrows to indicate a secondary exit from each room in the home.

Meeting Place

Choose a location outside the home where family members should meet once they have safely escaped. A neighbor's front yard or sidewalk may be an ideal meeting place.

Practice

Circle all of the exits in this home. Then with the color red, draw arrows from each room to show how you can exit the house using doors. Next, using the color blue, draw arrows to show how you can exit the house using windows. Draw a yellow star to show where your meeting place is. Answers on page 20.

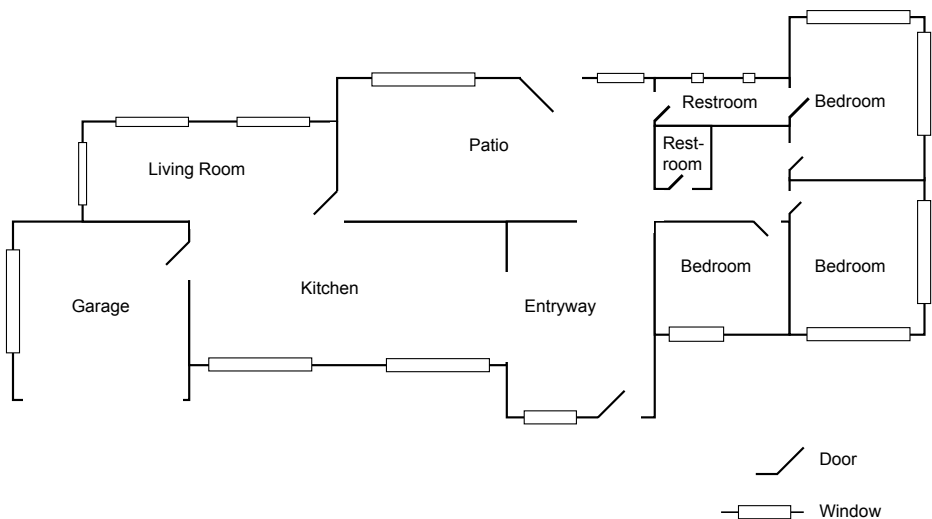

Remember: Practice, Practice, Practice!

Answer on pg 19



HELP SPARKY GET TO STACY AND KYLE!

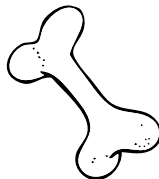
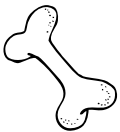
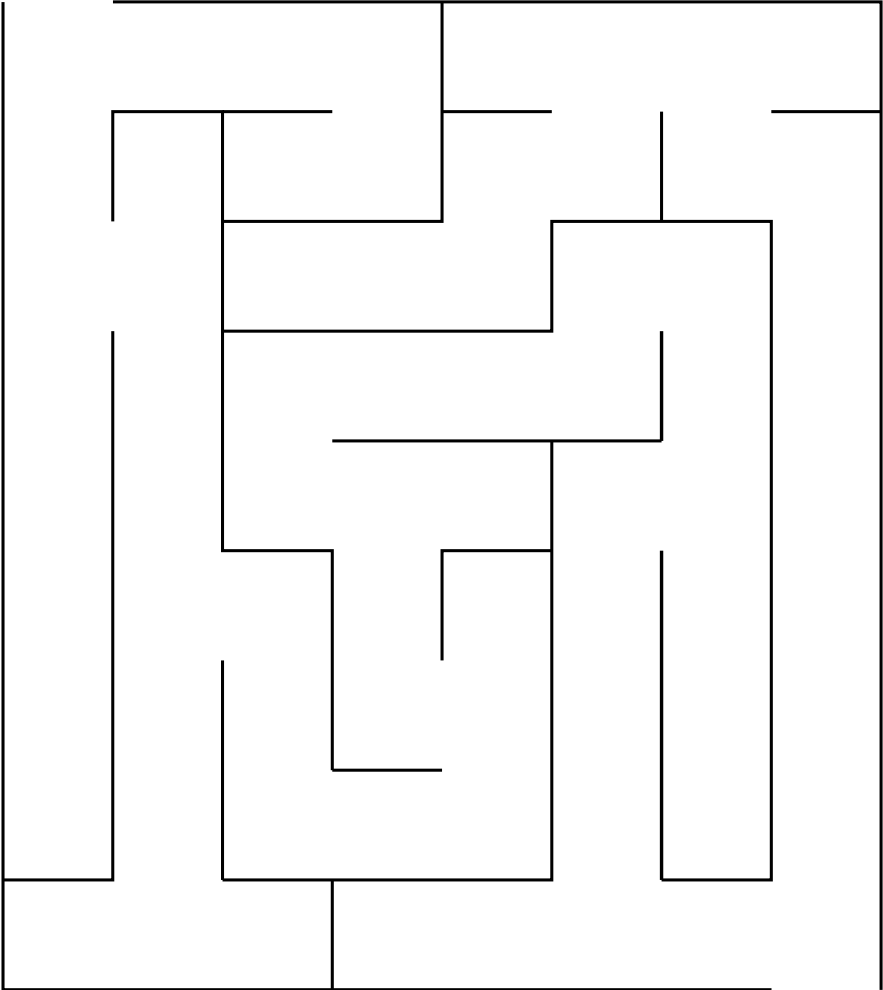

Answer on pg 19



Sparky's Secret Message

Use the letter key to help decode Sparky's Secret Message. Some of the key got burned, so you will have to figure out part of the code.

A	B	C	D	E	F	G	H	I	J	K	L	M
8				22	20		9					

N	O	P	Q	R	S	T	U	V	W	X	Y	Z
18	10			25		21	13				3	

$$\begin{array}{r} \text{E} \\ 19 \quad 22 \end{array} \quad \begin{array}{r} \text{R} \quad \text{E} \\ 20 \quad 4 \quad 25 \quad 22 \end{array} \quad \begin{array}{r} \text{A} \quad \text{E} \\ 1 \quad 8 \quad 20 \quad 22 \end{array} .$$

$$\begin{array}{r} \text{N} \quad \text{E} \quad \text{R} \\ 18 \quad 22 \quad 12 \quad 22 \quad 25 \end{array} \quad \begin{array}{r} \text{A} \quad \text{Y} \\ 7 \quad 15 \quad 8 \quad 3 \end{array} \quad \begin{array}{r} \text{T} \\ 5 \quad 4 \quad 21 \quad 9 \end{array}$$

$$\begin{array}{r} \text{A} \quad \text{T} \quad \text{E} \\ 2 \quad 8 \quad 21 \quad 11 \quad 9 \quad 22 \quad 1 \end{array} , \quad \begin{array}{r} \text{T} \quad \text{E} \quad \text{R} \\ 15 \quad 4 \quad 14 \quad 9 \quad 21 \quad 22 \quad 25 \quad 1 \end{array}$$

$$\begin{array}{r} \text{O} \quad \text{R} \\ 10 \quad 25 \end{array} \quad \begin{array}{r} \text{A} \quad \text{N} \\ 11 \quad 8 \quad 18 \quad 24 \end{array} \quad \begin{array}{r} \text{E} \\ 15 \quad 22 \quad 1 \end{array}$$

$$\begin{array}{r} \text{A} \quad \text{N} \\ 8 \quad 18 \quad 24 \end{array} \quad \begin{array}{r} \text{A} \quad \text{A} \quad \text{Y} \\ 8 \quad 15 \quad 5 \quad 8 \quad 3 \quad 1 \end{array} \quad \begin{array}{r} \text{E} \\ 21 \quad 22 \quad 15 \quad 15 \end{array}$$

$$\begin{array}{r} \text{A} \quad \text{N} \\ 8 \quad 18 \end{array} \quad \begin{array}{r} \text{A} \quad \text{T} \\ 8 \quad 24 \quad 13 \quad 15 \quad 21 \end{array} \quad \begin{array}{r} \\ 4 \quad 20 \end{array}$$

$$\begin{array}{r} \text{Y} \quad \text{O} \\ 3 \quad 10 \quad 13 \end{array} \quad \begin{array}{r} \text{E} \quad \text{E} \\ 1 \quad 22 \quad 22 \end{array} \quad \begin{array}{r} \text{A} \\ 8 \end{array} \quad \begin{array}{r} \text{R} \quad \text{E} \\ 20 \quad 4 \quad 25 \quad 22 \end{array}$$

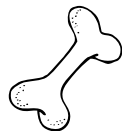
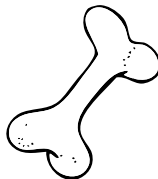

Answer on pg 19

Sparky the Fire Dog

You will need: 1 white square paper, 1 black crayon or marker and an adult to help

Step 1

Color black spots on your square white paper

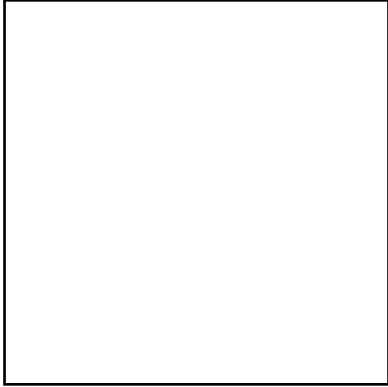

Step 2

Fold your paper in half diagonally, like the dotted line. The spots should be on the outside

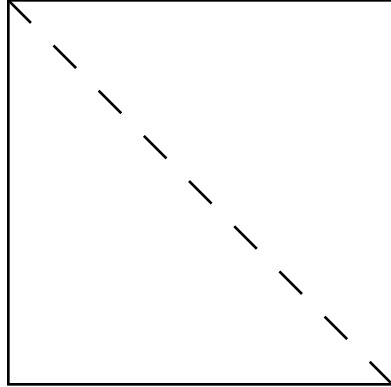

Step 5

Fold the corners of your triangle down, like the dotted lines.

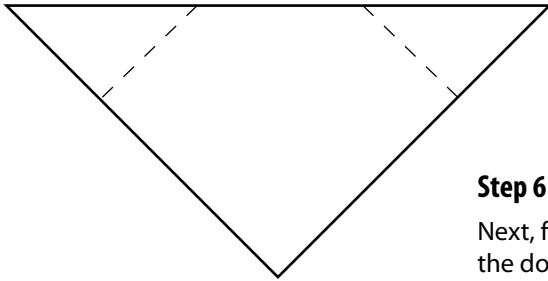

Step 6

Next, fold the bottom corner up, like the dotted line.

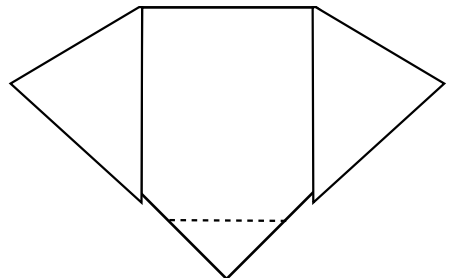

Step 3

You paper should look like this.

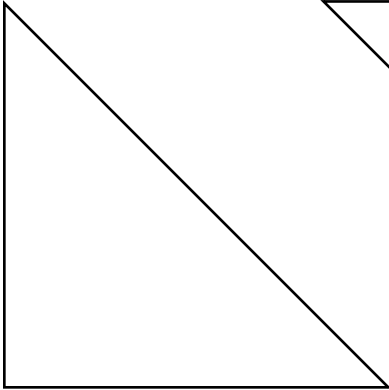

Step 4

Turn your paper so it looks like this.

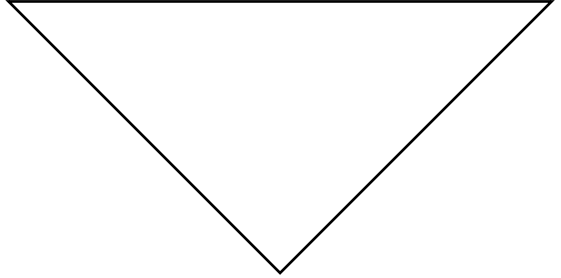

Step 7

Last, draw Sparky's eyes and nose, and now you're finished!

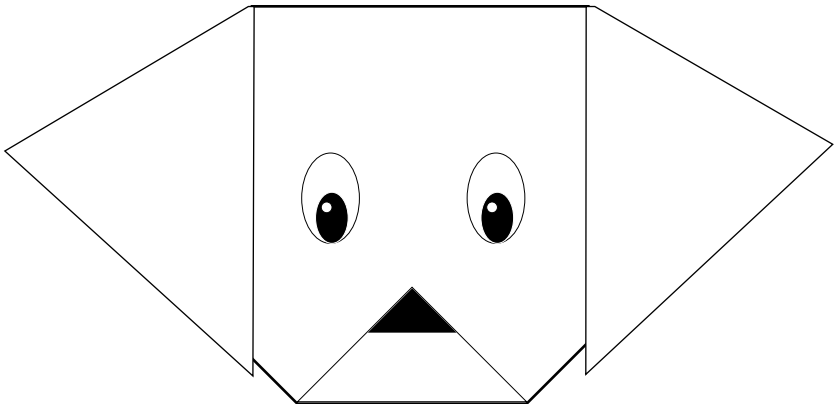



Help Smokey

Help Smokey get to his friends on the other side of the forest.

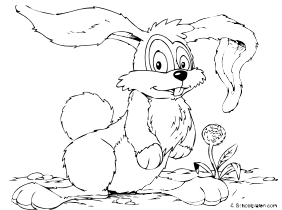
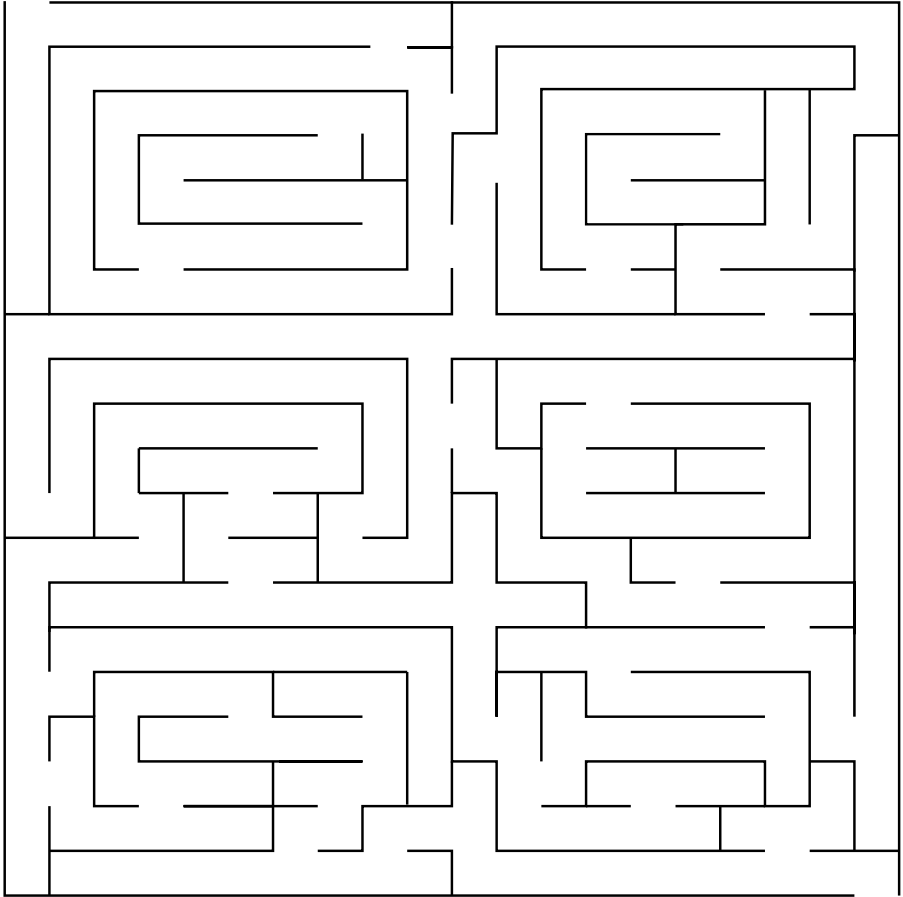

Answer on pg 19

Test Your Fire Safety Knowledge

Match the questions on the left to the correct answers on the right.

Questions:

1. How many smoke alarms should you have in your home?
2. What should you do if you ever see a fire?
3. When should you test your smoke alarm?
4. If your clothes catch fire, what should you do?
5. You should have an _____ ready in case of a fire in your house.
6. How often should you change the batteries in your smoke alarms?

Answers:

- A. Stop, Drop and Roll
- B. One a Month
- C. Once every six months
- D. Tell an adult
- E. One on each level of your house
- F. Escape Plan

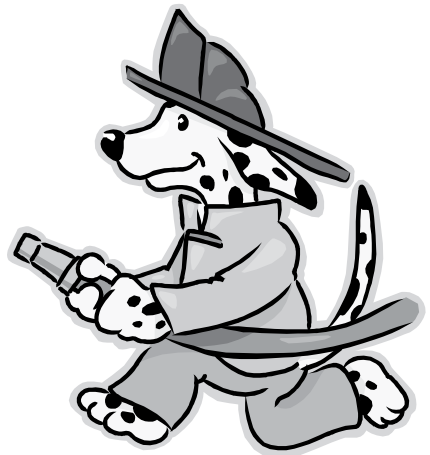

Answers on pg 19

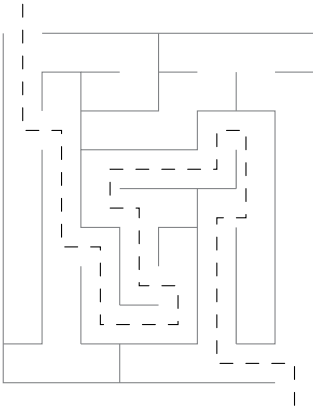
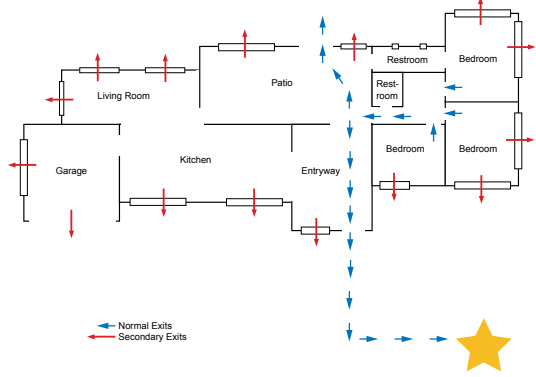
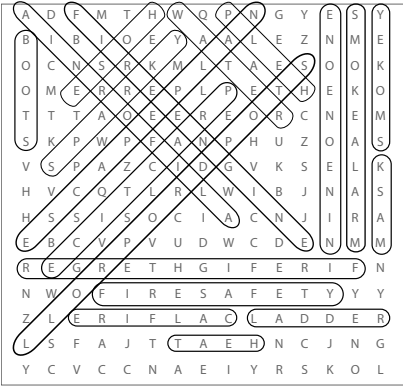

B 19	E 22	F 20	I 4	R 25	E 22	S 1	A 8	F 20	E 22					
N 18	E 22	V 12	E 22	R 25	P 7	L 15	A 8	Y 3	W 5	I 4	T 21	H 9		
M 2	A 8	T 21	C 11	H 9	E 22	S 1	L 15	I 4	G 14	H 9	T 21	E 22	R 25	S 1
O 10	R 25	C 11	A 8	N 18	D 24	L 15	E 22	S 1						
A 8	N 18	A 8	L 15	W 5	A 8	Y 3	S 1	T 21	E 22	L 15	L 15			
A 8	N 18	A 8	D 24	U 13	L 15	T 21	I 4	F 20						
Y 3	O 10	U 13	S 1	E 22	E 22	A 8	F 20	I 4	R 25	E 22				

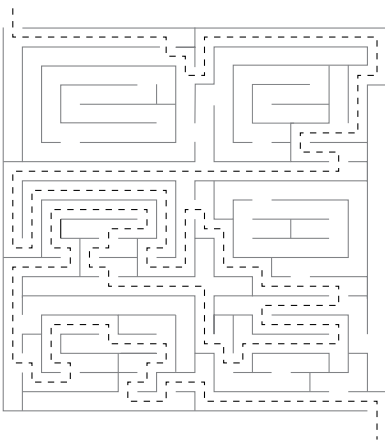

Questions:

Answers:

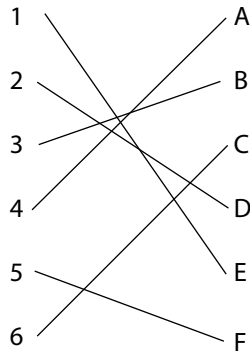



For More Tips and Information visit:

www.fire.ca.gov
www.smokeybear.com
www.sparky.com

This activity book was created by the Communications Department of CAL FIRE.
Smokey Bear™ is a trademark and service mark of the U.S. Forest Service
Sparky® and Sparky the Fire Dog® are registered trademarks of the NFPA
Selected images are © Edupics.com